

Music Theory Textbook

For MUSIC 220 at Manhattan College, Spring 2025

Version 1.15 created 1/10/25 by Dave Smey
Released under Creative Commons License CC BY-NC-SA.
Reproduction and classroom use freely permitted.
See <http://creativecommons.org/licenses> for more information.



Preface: Welcome to our textbook!

This collection of 26 short chapters is going to be our textbook for Fundamentals of Music Theory at Manhattan College. Writing my own materials has been a somewhat weird thing to do which sometimes has its shortcomings, but I think it is the right way to go for our theory class.

We will refer back to this book all semester long. You don't have to bring it to class, but I'll remind you to read up on the latest concepts before you try each homework assignment.

While this volume is perhaps not yet as polished as a "real" textbook, there are a few advantages to writing my own stuff. Obviously it is being provided to you at no additional cost, and you can go to our class website at <https://davesmey.com> and download a digital version to carry around on any device you want. Since I license it under the Creative Commons framework you can even gift copies to your friends - just don't sell it or take my name off of it.

And, as you'll see, I can do a lot of things that you'll never see in an expensive commercial text. I can write in my own voice, make jokes, express uncertainty, and explain things the same way I do in class. I can use lots of "white space" so that things look organized and clear. Our book will keep evolving from semester to semester, so if you see any errors (like typos, garbled sentences, examples that don't match their captions, etc.) let me know and I will fix them!

If you decide that you don't want to put 100% of your trust in this homebrew text from your professor, that's OK too. Here are a few additional texts that you might want to acquire for additional reference. I am listing each title in its most recent version, but often the smart play is to buy a used copy online in a slightly older edition.

Duckworth, William. *A Creative Approach to Music Fundamentals*. 11th ed. Boston: Cengage Learning, 2013.

This one used to be the official text for the course, and it will take you through the first two-thirds of the semester or so. As we get to more "advanced" topics, though, you might need a more advanced text. If you really want to invest in your theory library I'd also recommend

Kostka, Stefan M., Dorothy Payne, and Byron Almén. *Tonal Harmony: With an Introduction to Post-Tonal Music*. 8th edition. New York, NY: McGraw-Hill Education, 2018.

But regardless, whether you buy more books or not, I hope you get a lot out of this semester's course. Let's get started!

Table of Contents

1. Reading the Staff / 1
2. Rhythmic Basics I / 6
3. Solfège Syllables / 13
4. Piano Keyboard / 15
5. Whole Steps and Half Steps / 19
6. Sharps and Flats / 21
7. Rhythmic Basics II / 24
8. Scales I / 27
9. Key Signatures, Circle of Fifths / 29
10. 6/8 Time / 36
11. Minor Scales / 38
12. The “Fancy” Note Names / 42
13. Triads / 44
14. Intervals / 50
15. Diatonic Triads + Roman Numerals / 59
16. Triad Inversions / 62
17. Getting Started with 4-Voice Progressions / 65
18. I-V-I Progressions / 71
19. Using ii and IV Chords (Step Zone) / 74
20. Progressions that Move by Thirds / 77
21. Enter the Matrix / 82
22. Seventh Chords / 86
23. Inversion Symbols for Roman Numeral Analysis / 92
24. Intro to Harmonic Analysis / 96
25. Non-Chord Tones / 99
26. Progressions with V7 / 106 v v

The Very Beginning: Reading the Staves

To get started reading music, you need to understand the “note names” we use to refer to pitches.

The note names in English begin with the letter A and proceed up to G. After G they repeat, so the note above G is A (and the note below A is G.)

... E F G **A B C D E F G** A B C ...

These letter names correspond to the white keys on the piano.

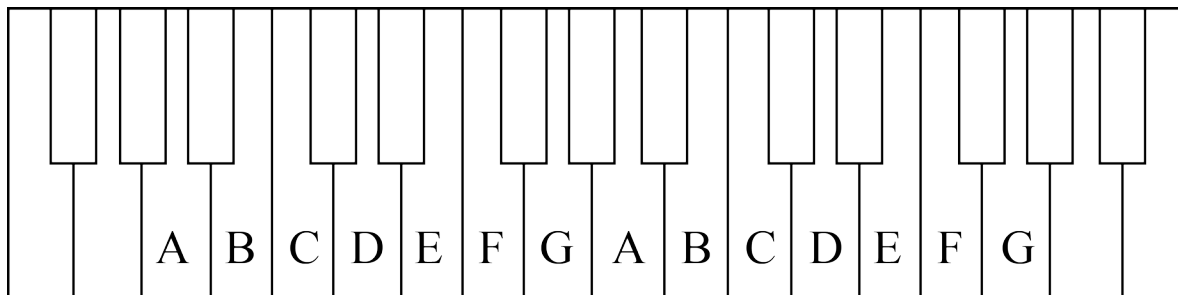

In written music the notes alternate between the lines and spaces on the staff, like so:

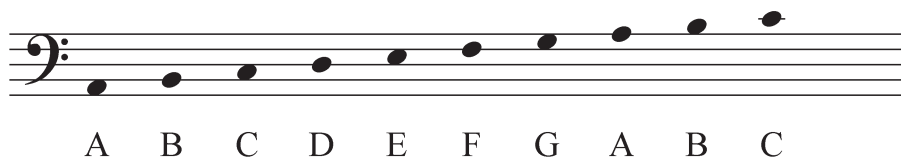

The Grand Staff

Piano music is usually written on the grand staff, a combination of treble clef and bass clef. The space in the middle is home to “middle C.” (Middle C is, unsurprisingly, the C that’s in the middle of the average piano keyboard, and it is pretty much the center of useful musical sounds.)

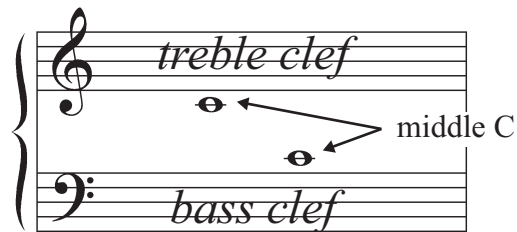

Treble Clef

On the far left of each staff there is a fancy-looking symbol called a clef. It tells you what the lines on the staff mean.

The treble clef is also known as the “G Clef.” It draws loopy circles around two different G’s.

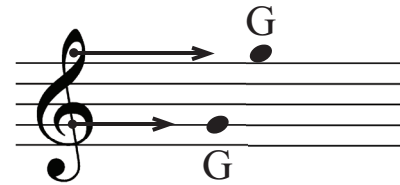

Making your own is easy in three steps.

1) Go up the center.

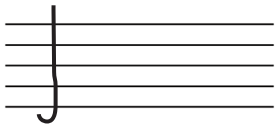

2) Loop around the top.

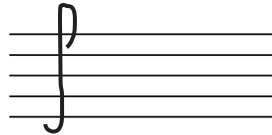

3) Make a big loop from bottom line to middle line.

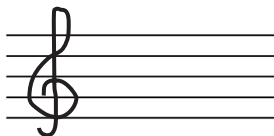

Memorizing the Lines and Spaces

People like to memorize the lines and spaces on the staff with little mnemonics.

To remember the lines on the treble staff people say “Every Good Boy Does Fine” or “Every Good Boy Deserves Fudge.”

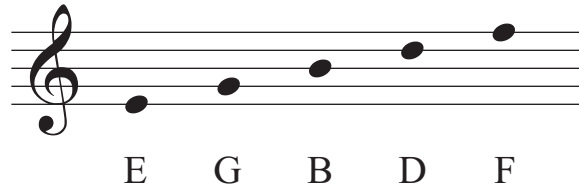

Remember, in hitting all the lines we are skipping over every other note, or making *thirds*.

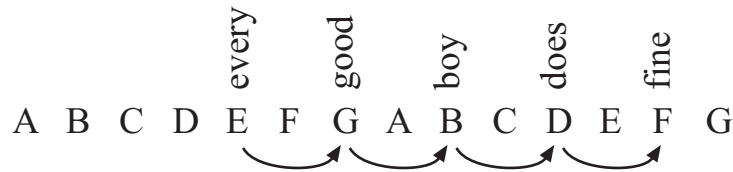

The spaces in the treble clef spell FACE

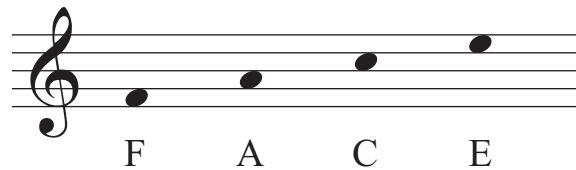

Bass Clef

Bass clef puts two dots around the note F.



The lines in the bass clef are “Good Boys Do Fine Always.” If you are tired of all of this good boy stuff you could also say “Great Big Dragons Fly Around” or “Good Burritos Don’t Fall Apart.”

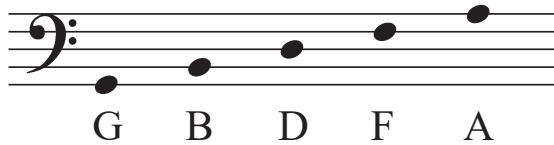

And the spaces are “All Cows Eat Grass.”

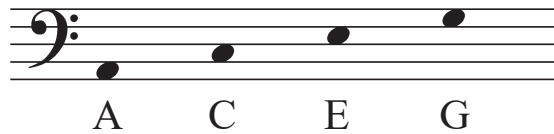

Ledger Lines

Every now and then you need to indicate notes that are just beyond the boundaries of our traditional staff and clefs. For these pitches you will need **ledger lines**. These are just extensions of the staff with short, temporary lines. They follow the same pattern as the regular staff, going line / space / line / space as you count up or down.

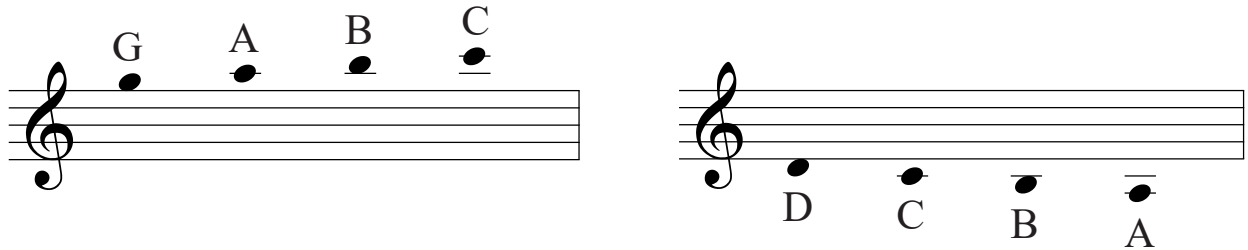

Theoretically there is no limit to the number of ledger lines you might stack up, but I would say that three is the practical limit. More than that will become too annoying to read.

Beyond the Mnemonics

As you begin to study music, you really don't want to have to stop and count up "every good boy..." with each new note. You've got to learn to read the staff as naturally as you can read words.

Doing practice drills on a computer can help - we will have a special web page that links to some computer programs and apps that I like.

Also, I've got a special handout for practice called "Level Up!" that starts off easy, focusing at first on only a few notes in the staff. By making the task simple and gradually increasing in difficulty I think one can master this somewhat tedious skill.

Chapter 2: Rhythmic Basics (Part One)

Rhythms in 4/4

Meter

The *time signature* (or metric signature) appears at the beginning of a piece. It tells you how many beats will be in each measure. This is not just technical information - the *meter* (i.e. the number of beats per measure) determines the overall “groove” of the piece. It is one of the most obvious things you can pick up just by listening.

The time signature includes two bits of information:

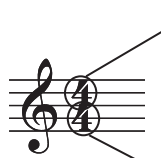

number of beats per measure

which “note value” gets the beat. For now, we’ll assume that the quarter note is getting the beat (which is the most common case, and it’s what it says here.) We’ll discuss other possibilities later.

Note Values (and Counting)

Usually, the *quarter note* is worth one beat.

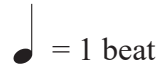

If we saw a measure full of quarter notes, we might write the beats below the staff, like so:



And we’d “count it out” by simply saying “one, two, three, four.”

The *half note* is usually worth two beats.

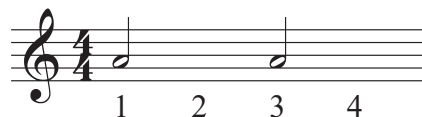
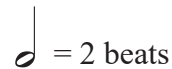

We would count it by saying one and three loudly, but maybe also mentioning the two and four - like “one, (two), three, (four).”

A *whole note* is usually worth four beats.  = 4 beats

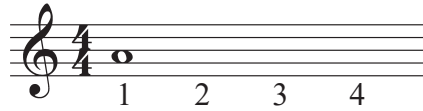

There are also rhythmic values that are worth a fraction of a beat.

Eighth Notes

An eighth note is half the value of a quarter note.  = 1/2 of a beat

(Or in other words, it moves twice as fast as the quarter.)

When you see eighth notes on the staff, you add a plus between the beats...



...and you'd count this out by saying "one and two and three, four."

A single eighth note has a "flag" that hangs down from it, as in the measure above. However, the notes are often connected together with beams, like in the following example:



We'll talk more about the beams later!

Sixteenth Notes

A sixteenth note is a quarter of the value of a quarter note.  = 1/4 of a beat

When we see sixteenth notes, we can insert "e" and "a" into the beats...



and we could say "one *eeh* and *uh* two *eeh* and *uh* three, four"

Rests

Rests indicate silence, rather than sound. Each note value has a corresponding rest.

quarter-note rest



half-note rest



whole-note rest



eighth-note rest



sixteenth-note rest



Drawing your rests

The quarter-note rest is terribly difficult to draw the way it appears in professional music. Most people just make a kind of squiggle, like so:



With the eighth and sixteenth-note rests, the “flag” from the note simply attaches to a diagonal line.

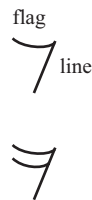

Ties, Beams, and “Showing the Beat”

A *tie* connects two notes together, creating one long note that is the sum of both.



This is useful when you have a long note that hangs over from one measure into the next. When this occurs you must break it up into parts and use a tie to connect them.



Tying the note over into the next measure is a form of “showing the beat.” The whole passage is easier to read because we can see that the note continues at the beginning of the next measure.

When you are working with the subdivisions of the beat (the “ehs”, “ands” and “uhs”), you also must take care to visually separate each beat. We’ve already seen that a beam simply connects consecutive notes together visually - it doesn’t change how they sound.



We beam notes within the beat together, but separate them from the notes in the next beat. This makes it easy to scan the measure and see where the beats are.

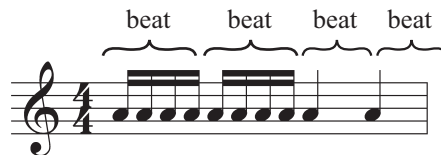

Note how there is a break in the beams where the second beat starts.

When you have notes that “hang over” from one beat to the next, you should break them into parts and tie them together.

hanging over hanging over

1 2 + (3) + a 4 + 1 + 2 e + a (3) 4

Notes that hang over the beat are *syncopated*, and they can be tricky to understand and execute.

Eighth and Sixteenth Combos - the “Grasshopper” and “Telephone” Figures

We’ve already talked about how you beam together sixteenth notes that fall within a beat.

beat beat beat beat

There will also be occasions in which one beat contains a mixture of eighth notes and sixteenths. Let’s look at two possibilities.

When an eighth note is followed by two sixteenths, you would count it as “1, + a” and you would draw it with one beam that goes all the way across and a second line that connects only the sixteenths.

1 + a

The word “grasshopper” is a useful verbal cue that can remind you how to execute this figure.

If the two sixteenths come first, that’s the “telephone” figure. It is counted “1 e +” and drawn with the two lines at the beginning.

1 e +

Beaming these mixed figures is confusing at first for a lot of students, but if you learn them like they are words it will become easier to just drop them into place when needed.

Ways to Practice Rhythms

There are a variety of ways you can execute rhythmic passages for practice.

1) Tapping a beat + executing the rhythm.

This is probably the best method for beginners. Many people like to tap the beat with a hand or foot while they perform the written rhythm orally, by saying “ta ta taaa.” Two-handed tapping (one on the beat, one on the rhythm) or simultaneous foot-tapping and clapping are also possible.

2) Counting out loud

The simplest way to count out loud is to say all four beats, with extra emphasis on beats where there is a written rhythmic value. Only add subdivisions (the “eehs” “ands” and “uhs”) as needed. So if you saw this:



You could count “one! (two) three! (four).” And this:



would be “one and two and three, four!” (all loud.)

3) Conducting and saying “ta”

Perhaps the most sophisticated and musical way to practice your rhythms is to conduct with one hand while you say the rhythm on a neutral sound like “taaaa.” This will surely feel awkward and uncomfortable at first, but with practice it becomes automatic and easy! Often there is a sense that your arm is counting *for* you, and you can sometimes figure out rhythms by looking at your pattern and noting what position you are in.

Here is the conducting pattern for 4/4, which makes a sort of upside-down T. Practice this motion at different speeds before you try reciting a specific rhythm.

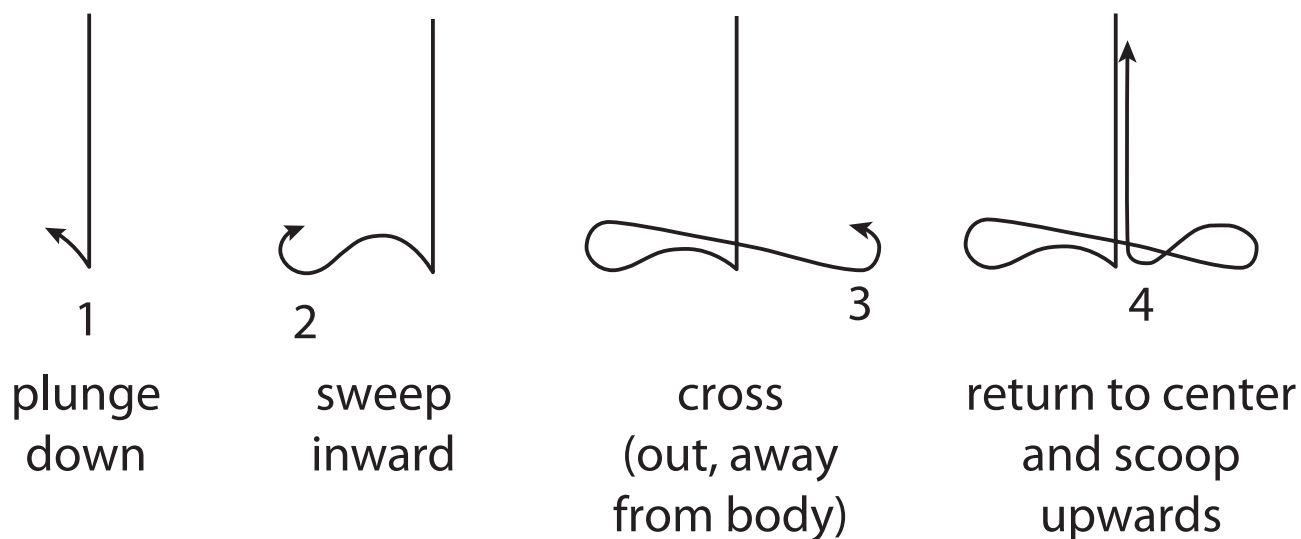

Chapter 3: Singing Melodies with the Solfège Syllables

Another major skill we are going to work on in this class is *sight-singing*, the practice of looking at a melody, imagining what it sounds like, and singing it out loud. We'll use a system of naming the notes in the scale as an aide to figuring out what things sound like -- these are the solfège syllables.

Solfège syllables have been in use since the Middle Ages. One influential proponent of this method was Guido d'Arezzo (ca. 992-1033). He famously mapped the syllables to the joints in the hand, so that he could point to his hand to illustrate how a melody would go.

The Guidonian hand was pretty complicated, in part because there were only six syllables and you could match them to different parts of the scale. Happily, our contemporary system is a lot simpler. If we see a melody in C major, we'll name the notes in the scale like so:

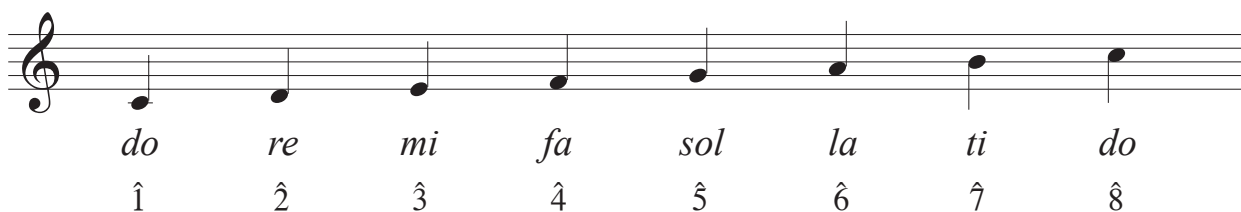
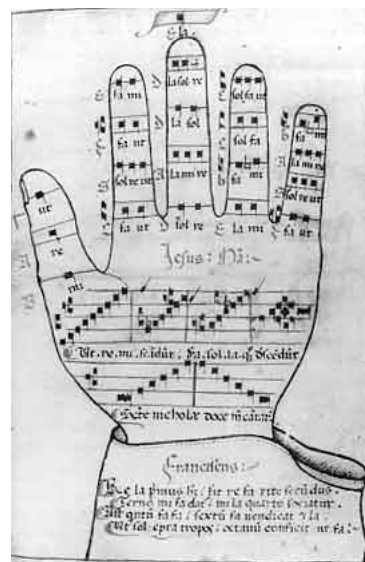

(The numbers with carets are another way to indicate scale-degrees. Our text will frequently refer to $\hat{1}$ $\hat{2}$ $\hat{3}$ and so on.)

The European System (“Fixed do”)

You may know that in many languages the solfège syllables are simply the names of the notes - instead of saying “A, B, C...” and so on many people say “la, si, do...” These folks are using a fixed do system in which “do” always means C, no matter what the context.

We are going to use an American variant of solfège which I will explain on the next page...

Movable Do

Since we already have names for the notes, many American educators apply solfège syllables in a slightly different way - they want *the same part of the scale* to always have *the same name*.

For instance, say we are working on a melody in F major. F is the beginning and end of the scale, and it is the “home note” that we keep returning to. In this context we’ll call F *do* and the rest of the notes in the scale will fall into place like this:

The image shows a musical staff in treble clef with a key signature of one flat (Bb). The notes of the F major scale are written from left to right: F, G, A, Bb, C, D, E, F. Below each note is a solfège syllable and a finger number. The syllables are: do, re, mi, fa, sol, la, ti, do. The fingerings are: 1, 2, 3, 4, 5, 6, 7, 8.

<i>do</i>	<i>re</i>	<i>mi</i>	<i>fa</i>	<i>sol</i>	<i>la</i>	<i>ti</i>	<i>do</i>
1	2	3	4	5	6	7	8

(Of course, we haven’t even gotten into scales and key signatures, so there’s no need to worry about movable do just yet. We’ll start out with a bunch of melodies in C major.)

Chapter 4: Meet the Piano Keyboard

“Why should I learn about the piano?” you might ask. There are a few good reasons! It’s extremely useful for understanding musical space - the notes are laid out in a sort of grid that is very easy to understand, and there is a clear division between white and black keys which tells you a lot about how our musical notation system works.

Also, it’s the ultimate instrument for understanding how notes combine to make harmonies. With a full two-handed technique you can mimic the texture of a chorus or orchestra -- this is why most Classical composers have used the piano as their main compositional tool.

Getting Oriented

The first note you want to find is probably middle C. Most beginning piano methods start with music in the key of C major, and so this will be your most useful reference point. To find C, look at your black keys first. They have an alternating pattern of two and three keys grouped closely together. Find a group of two keys, and play the white note immediately to the left of it. That’s a C!

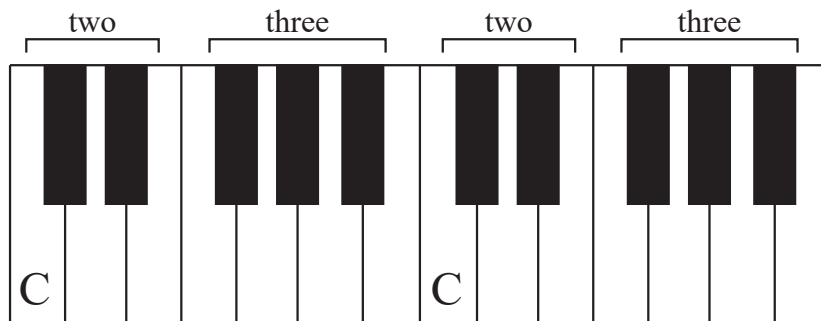

There are probably multiple Cs on your keyboard instrument. A standard 88-key piano has eight of them. Middle C should (unsurprisingly) be in the center. It will probably sound like a perfectly “medium” note to you, neither low nor high.

The white keys on the piano correspond to the plain letter names we use to name notes. You can count up or down from C and find all of the other tones.

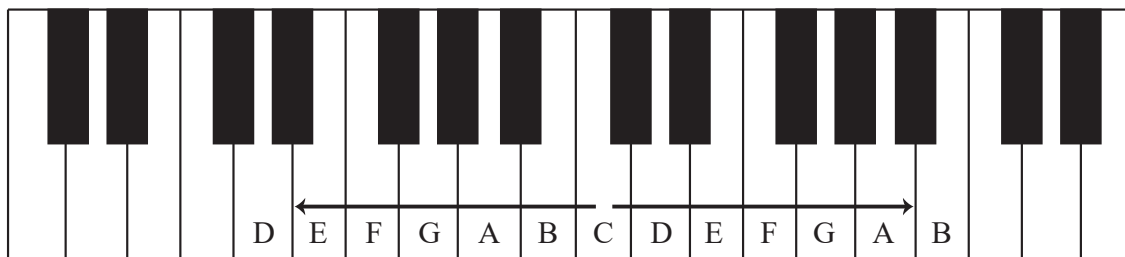

In the beginning we'll stick to the key of C major, which uses only these white notes.

Fingering

If you are going to actually play the piano, you need to understand the concept of fingering. There are times when it really makes sense to pay attention to how your hand moves while you play. Pianists use a number system to refer to the different fingers - the thumb of each hand is 1 and the pinky is 5. When you see a little number above a note, it means "play this note with this finger."

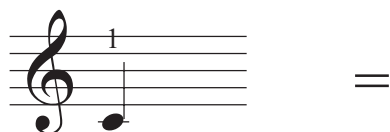
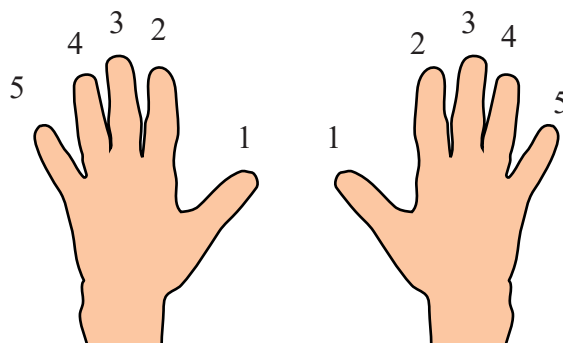

(You will also want to write your own fingerings in the music to remember the best way to play it.)

In general the music in the top staff is usually played with the right hand, and the bottom staff is played with the left.

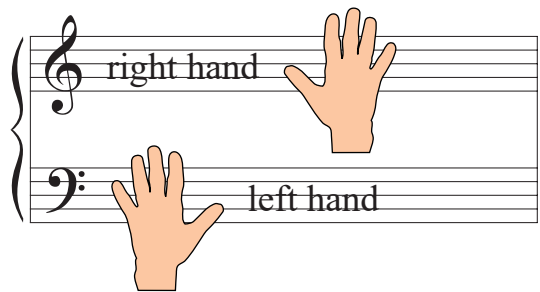

You usually want to keep your hand in a relaxed shape that covers about five white keys (one for each finger.) But sometimes a melody continues for more than five notes - what do you do then? Sometimes you will need to cross fingers over or under each other in order to continue the line and make a smooth connection.

In order to play this scale I'd cross my thumb under my third finger.

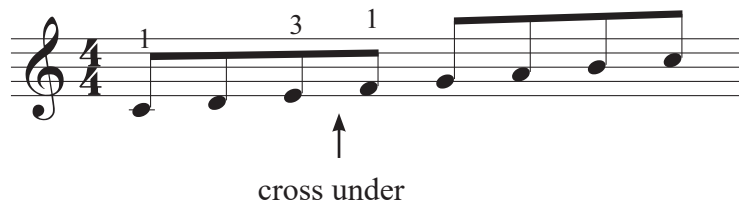

And to play this descending line I'd cross one finger over my thumb.

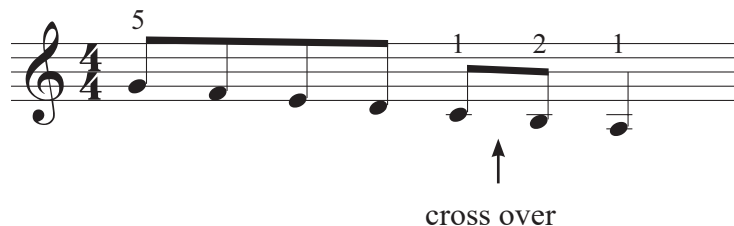

But, if you use a beginner's piano method you'll probably start with easy pieces that don't require a lot of fancy fingering.

Here is a paper piano that you can use for reference.

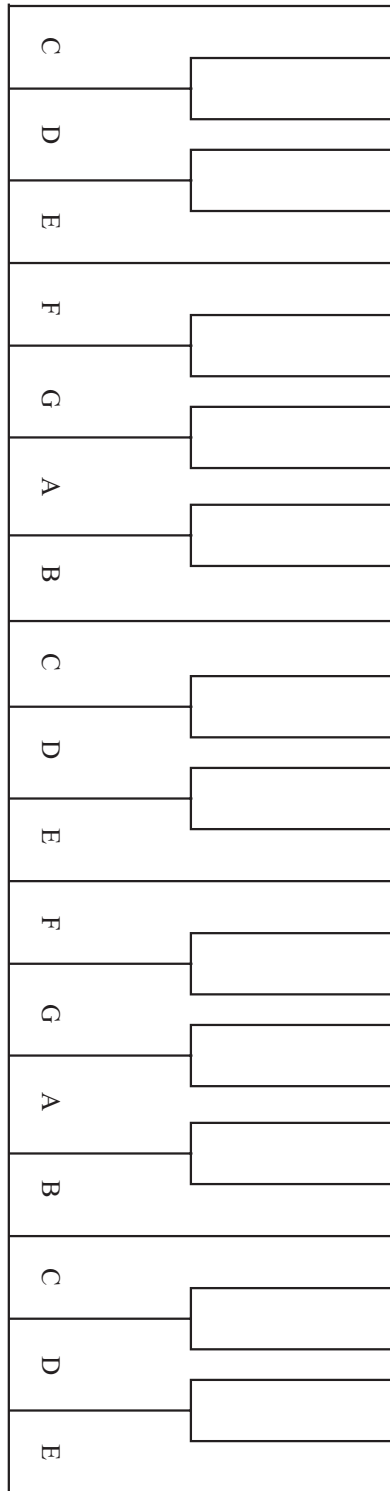

Chapter 5: Whole Steps and Half Steps

It is time to define two small musical *intervals*, the whole step and the half step. In general, we use intervals to describe the distance between two notes. Whole steps and half steps are (almost) the two smallest intervals you can make, and we are going to talk about them quite a bit in the next few chapters.

(The actual smallest interval would be the *unison*, which is the distance between a note and another copy of that note, on the same pitch. I will leave it to you to decide whether that counts.)

These two notes are both G's, and their distance apart is a unison.



Half Steps

Let us tackle the half step (or “semitone”) first. For now, we will say that any two keys that touch each other on the piano are a half step apart. One half step will usually take you from a white key to a black key, or vice versa.

some half steps

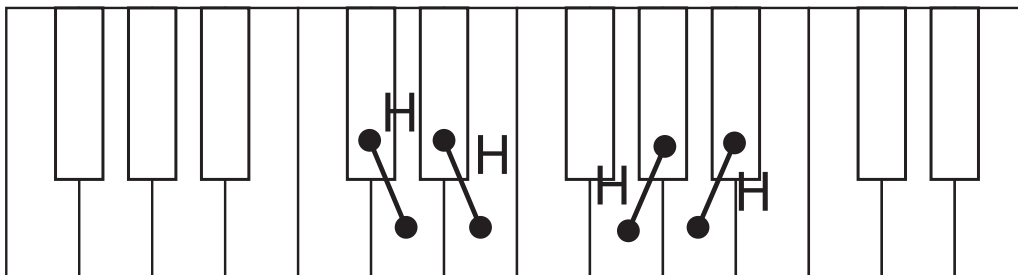

Also, there are two spots in the piano keyboard where the white keys touch each other directly, with no black key in between. They are also a half step apart.

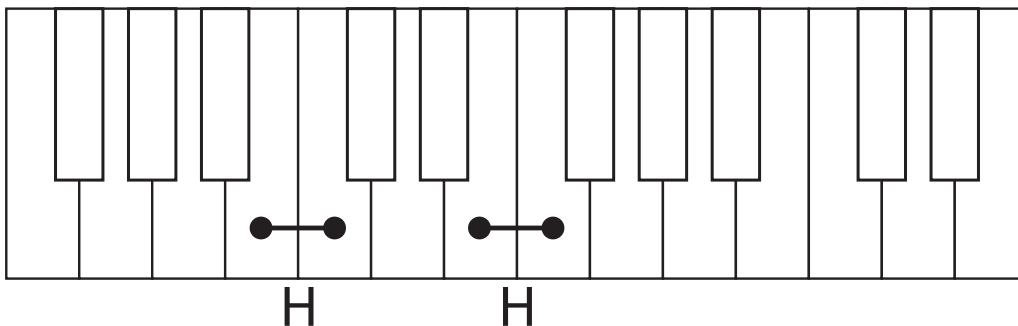

(It may appear that *all* of the white keys “touch each other,” but this is an illusion! The intervening black key means that they are more than a half step apart. ☺)

Whole Steps

A whole step (or “whole tone”) is equivalent to two half steps. On the piano, this will usually carry you from one white key to another or one black key to other, skipping over the key in between.

some whole steps

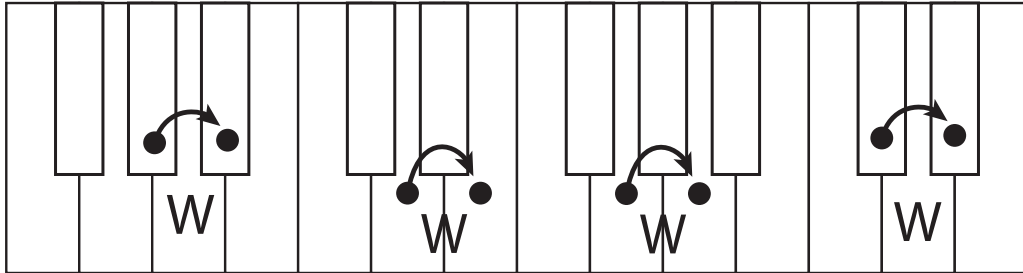

The places on the keyboard where two white notes touch each other create a slightly awkward zone where you have to count your whole steps carefully.

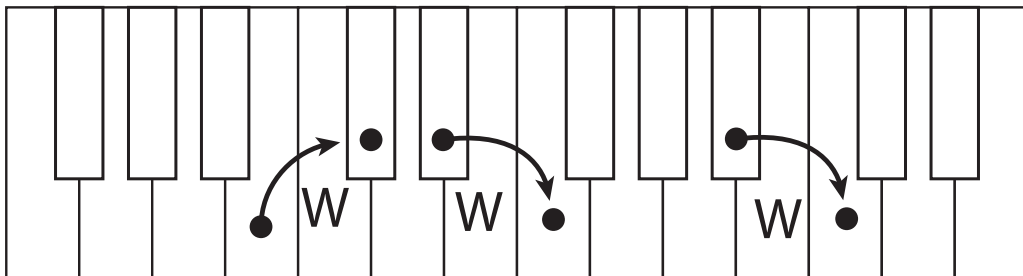

Chapter 6: Accidentals (The Sharps and Flats)

Up until now we've only named the "plain" notes that correspond to the white keys on the piano, but you are probably aware that the majority of music also uses sharps and flats. These modifications to our basic pitch notation are called *accidentals*.

The way accidentals work is pretty simple. Sharps push a note up, and flats pull it down. So when you add a sharp or flat to a note, it simply means the note a half-step higher or lower than the "plain" version. On the piano, this will frequently mean the black key to the right or left of the usual white key.

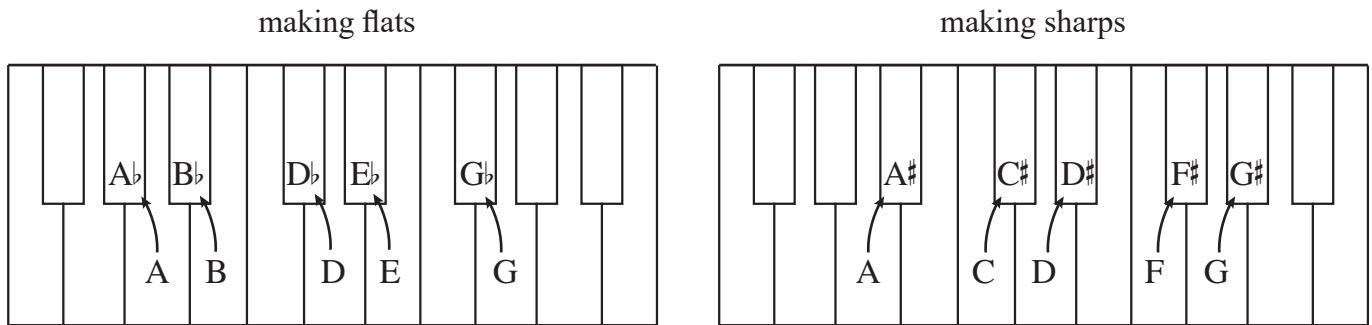

Enharmonic Equivalence

You might notice, however, that you can approach a black key from either the right or the left -- this means that the same key can have more than one name.

The note between C and D, for example, could be called either C sharp or D flat. We say that C sharp and D flat are *enharmonically equivalent*.

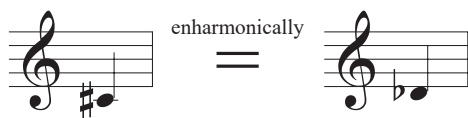

We'll learn later that it matters which one you choose! You need to "spell" your chords and scales correctly, and picking C sharp when you need a D flat can be like spelling the word "car" with a K.

The black-key notes aren't the only ones that have more than one enharmonic equivalent - white notes have more than one name as well. Believe it or not, there is such a thing as C flat, F flat, B sharp and E sharp. These are relatively rare, but they do come up for various reasons.

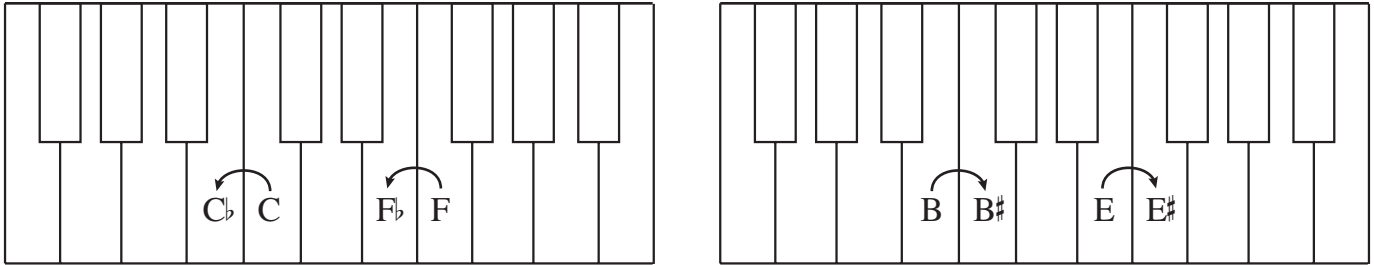

Notation

When you are drawing notes on the staff, you put the accidental before the note. It will have an effect on all the notes that follow in that measure as well, so if you apply a flat to your first G, all subsequent G's will also be flattened. (This only applies to the notes on the same line or space, however.)

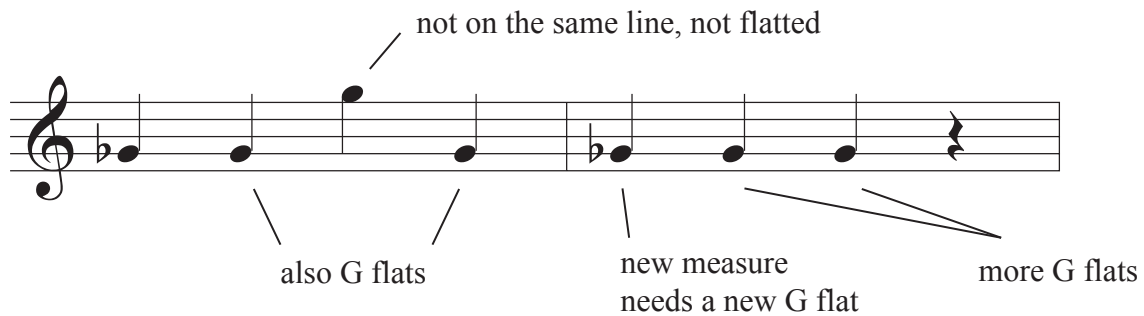

When we speak or write about the notes, however, we always mention the accidental after the note, not before. We say and write G flat or G \flat .

The Natural Sign

The natural sign indicates the "plain" letter name. This is useful when you've had an accidental earlier in the measure and you want to undo it. So, if you've had a G-flat earlier and you want plain G, you'd indicate that by notating G natural. (Also, it's much more correct to say "G natural" rather than "plain G!")

 natural

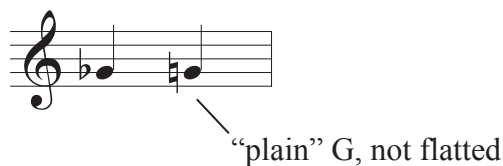

Double Flats and Double Sharps

Double flats and double sharps alter a note so that it is either two half steps higher or lower.

The double flat is written exactly the way you'd expect...



...but the double sharp looks more like a small X.



Thus the white notes have enharmonic equivalents that can be made with double flats or sharps.

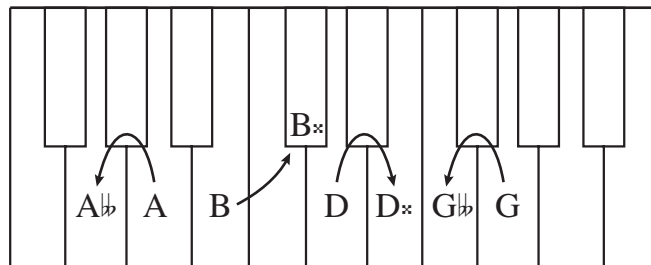

Key Signatures

Key signatures appear at the beginning of a piece, and they are usually repeated at the beginning of each line in the sheet music. They consist of one or more accidentals floating without any notes attached to them. These flats or sharps affect every note in the entire piece, unless they are undone with naturals. Unlike normal accidentals that you attach to notes, they also affect the same letter name in different octaves - so, for instance, if your key signature has an F sharp in it it means that all kinds of F's will now be F sharps, not just those on that top line.

F[#] in key signature

all of these are F[#]

undoing the F[#] with a natural

Chapter 7 - Rhythm, Part II

The Dot and 3/4 Time

In this chapter we are going to continue to speak as though we are in 4/4, 3/4, or any other signature with a 4 on the bottom. These are meters in which the quarter note gets one beat.

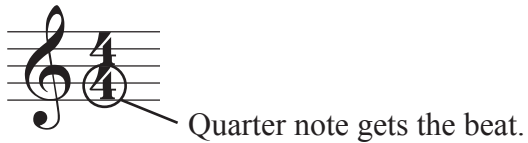

One Dot = Increase by 50%

Any kind of note or rest can be appended with a dot. This increases the rhythmic value by 50%.

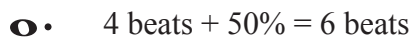

In 4/4 the dot is frequently used to make the “heartbeat rhythm.”





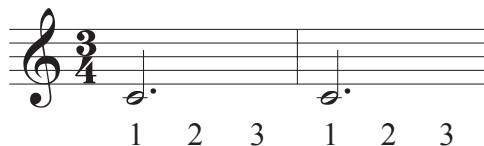

...and in 3/4 time we'll use dotted half notes to fill up the measures.



The Double Dot

But that's not all! You can actually add another dot which increases the note by an additional 25% (or 50% of the 50%). Theoretically there is no limit to the number of dots you could add in this way, though the rhythmic value of such creations would quickly become very difficult to figure out.

	1 beat + 50% + 25% = 1 3/4 beats		1/2 beat + 50% + 25% = 7/8 beat
	2 beats + 50% + 25% = 3 1/2 beats		1/4 beat + 50% + 25% = 13/16 beat
	4 beats + 50% + 25% = 7 beats		

The double dot is often used to take the heartbeat rhythm and exaggerate it, so that the pickup note is even shorter.

The dot fills up the space until the short note.

single 

1 2 + 3 4

More space, quicker short note.

double 

1 2 e + a 3 4

Triple Meter

Triple meter (or 3/4) is pretty simple. Instead of counting four beats per measure, we count three (as in a waltz.) If you want to conduct in 3/4, you mostly just edit out one beat from the pattern. This makes a sort of triangle shape.

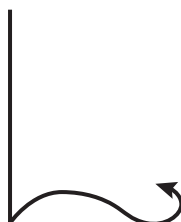
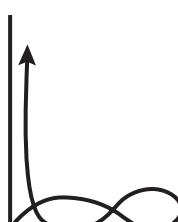
		
1	2	3
plunge down	sweep out (away from body)	return to center and scoop up

Counting out measures in three is also straightforward.

A musical staff in 3/4 time with a treble clef. The notes are: quarter, quarter, quarter, quarter, quarter, quarter, quarter, quarter, quarter, quarter, quarter, quarter. Below the notes are the counting numbers: 1, 2, 3, +, 1, 2, 3, 1, 2, +, 3, 1, 2, 3.

Duple Meter

Duple meter, or 2/4, is sort of an abbreviated 4/4. We conduct it in a J shape.

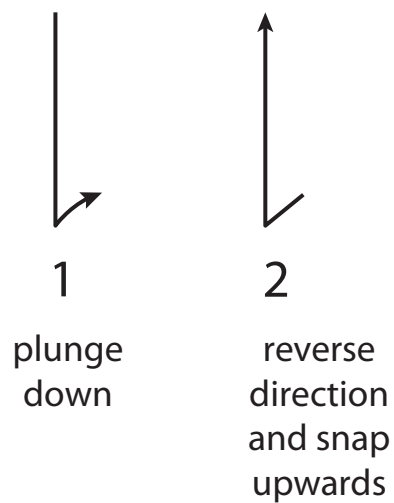

...and we count it how you might expect.

A musical staff in 2/4 time with a treble clef. The notes are: quarter, quarter, quarter, quarter, quarter, quarter, quarter, quarter, quarter, quarter, quarter, quarter. Below the notes are the counting numbers: 1, 2, +, 1, 2, 1, +, 2, 1, 2.

Chapter 8: Scales I

Building Step-By-Step

There are two basic ways to understand your scales. In this lesson we'll think of the intervallic shape of the scale (in other words, the pattern of whole steps and half steps), and we'll carefully build them one note at a time. I sometimes like to call this the "inchworm" method.

In our next lesson we'll start learning key signatures, which take a sort of inventory of the sharps and flats that appear in the scale. A good musician can think about scales both ways, with one method double-checking the other!

Half Steps and Whole Steps

We discussed this on pp. 18-19, but let's review.

A *half step* is the distance between any two adjacent piano keys.

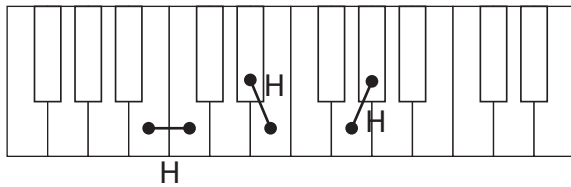

A *whole step* is two half steps.

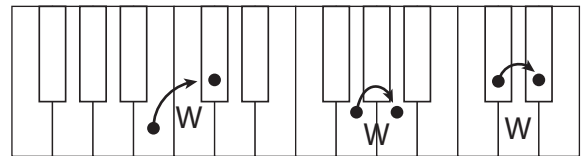

The Major Scale Pattern

Maybe you already know that the C major scale is all the white notes on the piano from C to C. We can look at it and see the pattern of whole and half steps that all major scales make. You need to memorize this sequence! We can write it down as WWHWWWH, and it rolls off the tongue in a fairly appealing and easy-to-remember way - "whole whole half, whole whole whole half."

C major scale

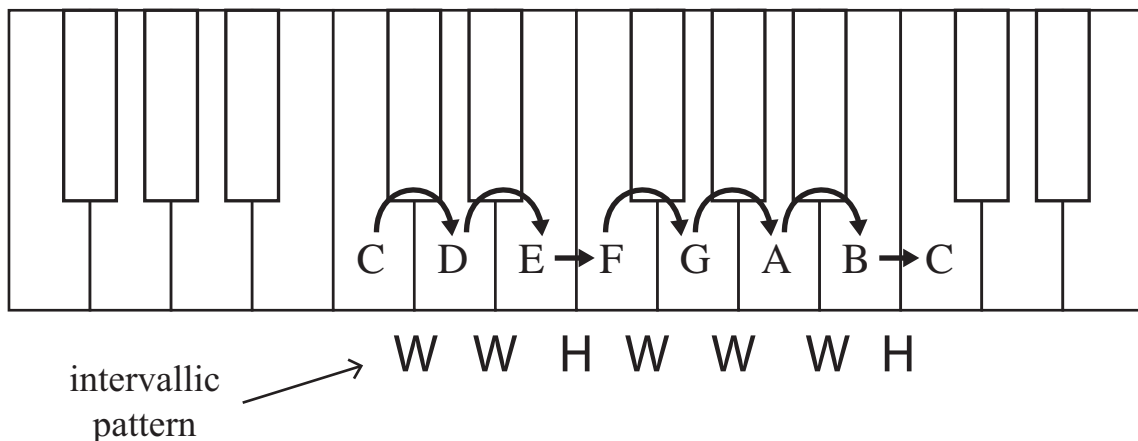

So if you want to build a major scale on a note other than C, you can pick your starting note and carefully build the WWHWWWH pattern. Here's a B \flat major scale.

B \flat major scale

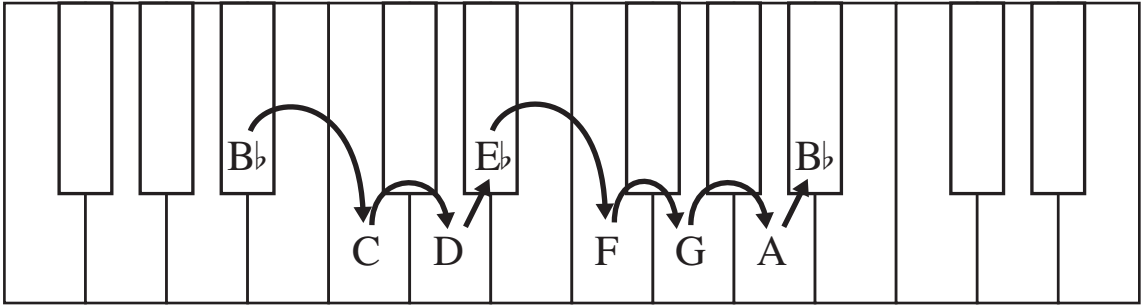

(same intervallic pattern) W W H W W W H

Scales must hit every letter

Major and minor scales proceed sequentially through our musical alphabet. No letter is used twice and no letter is skipped over. For major scales you will use only sharps or flats, never both.

CORRECT B \flat C D E \flat F G A B \flat

INCORRECT B \flat C D (D \sharp) F G A B \flat

two D's, no E

On the staff the notes should proceed through every line and space.

YES



NO



Chapter 9 - Key Signatures and the Circle of Fifths

The key signature is a set of sharps or flats that you put at the beginning of each musical staff. I'll show the key signature for B \flat major below. It means "every B note that follows is really a B \flat , and every E note is really E \flat ."



You can learn to write out scales quickly and easily by memorizing key signatures. Let's imagine that you've constructed a B \flat major scale using the WWHWWWH pattern, and you write it in letter names like so:

B \flat C D E \flat F G A B \flat

You can use your knowledge of the B \flat major signature to double-check your work. You'd say "I know the scale should have B \flat and E \flat in it, so that looks correct!"

The Circle of Fifths

People learn their key signatures by memorizing the circle of fifths. This is a map of all possible keys, organized in a clock-like circle with twelve positions. We'll just start the top part of it on this page.

At the twelve o'clock position, you put C major. It has no sharps or flats.

As we travel clockwise, we'll add sharps to each key. The first key gets one sharp, the next one gets two, and so on. (I'll explain exactly which sharps we are adding in a second.)

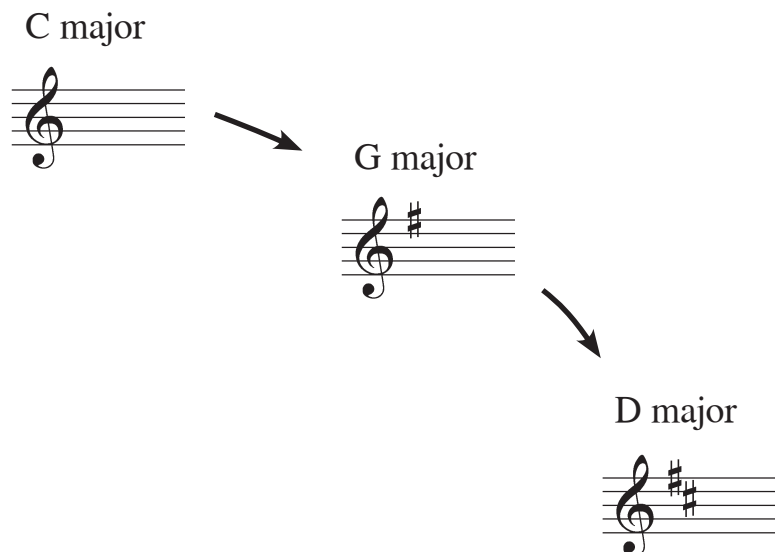

Here is the entire sharp side of the circle.

C major



G major



D major



A major



E major



C# major



F# major



B major



Building the Flat Side

In order to build the flat side we are going to go down in fifths. So first we climb down in C major and get to F.



In F major, we can count down and get to B \flat . Because we are using F major we arrive on B \flat , not B. Actually measuring each fifth down is really kind of complicated. Like I've said, most people just memorize the order of scales in the circle.



With each step in the circle we will add a flat to the fourth scale degree. F major is our first flat key, and its fourth note is B \flat . Then, to make B \flat major, we need a flat on its fourth tone (E \flat).

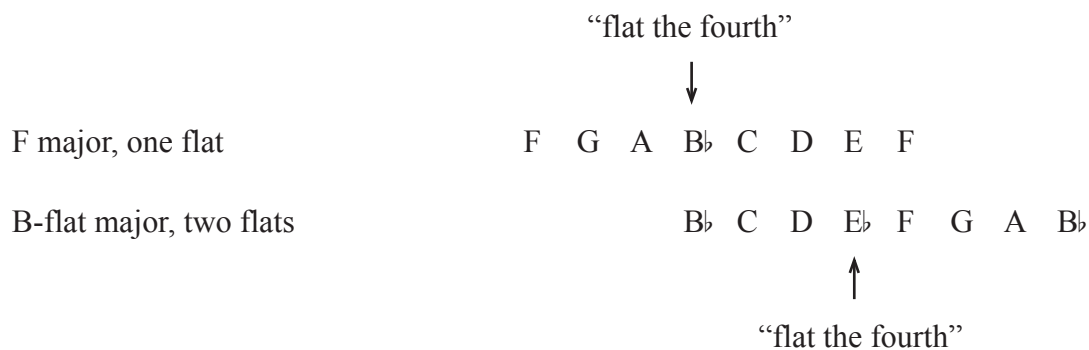

F major









C major

B \flat majorE \flat majorA \flat majorD \flat majorG \flat majorC \flat major







The “Easy” Keys

In the beginning I recommend that you memorize the top half of the circle, from three flats to three sharps. You need to know what key is in each position, how many sharps and flats it has, and what those specific accidentals are.

		C major		
	F major		G major	
				
B \flat major			D major	
				
E \flat major			A major	
				

Enharmonically-Related Keys

Now, I told you there were 12 positions in the circle, like a clock, and yet you may have noticed that both the sharp side and the flat side curl around past six o’clock. There are a few overlapping keys! These are *enharmonically related*, meaning that they are drawn differently on the staff but played on the same keys of the piano. So, we’ll need to make our circle more like an overlapping spiral, and fill in both the sharp version and the flat version of these keys.

	C \sharp major		B major
		F \sharp major	
	/		\
D \flat major		G \flat major	C \flat major
			

The Order and Placement of Sharps in the Key Signature

When you write a key signature, you are supposed to always list the accidentals in the same order and in the same place on the staff. You can think of the sharps and flats as two long sequences that you have to memorize - each key simply rolls out one more sharp or one more flat in the series.

The sequence of sharps, for instance, is **F# C# G# D# A# E# B#**. As we go around the circle we roll out this sequence one at a time.

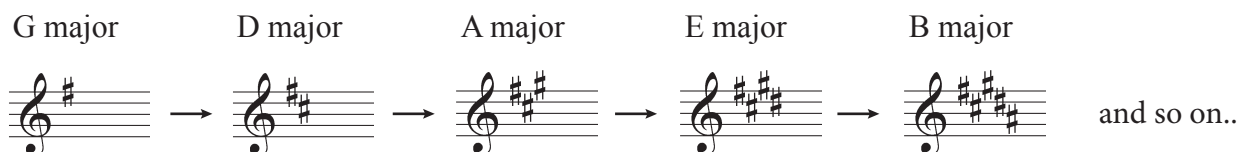

If you study the signature for C# major you see that you are supposed to distribute these in a 2-3-2 pattern in both the treble and bass clefs.



The Order and Placement of Flats

The order of flats is **Bb Eb Ab Db Gb Cb Fb**. Some enterprising students have noticed that it is the reverse of the sharps pattern.

The key signature for Cb major shows that the flats are supposed to be placed in a simple zigzag.



Here is the whole circle, for your reference.

Diagram illustrating the 12 major scales on a treble clef staff, arranged in a circle around the C major scale.

The scales shown are:

- C major
- F major
- B \flat major
- E \flat major
- A \flat major
- C \sharp major
- D \flat major
- F \sharp major
- G \flat major
- G major
- D major
- A major
- E major
- B major
- C \flat major

Chapter 10 - 6/8 Time

When we were first introduced to the idea of meter, I said that the bottom number in our time signatures indicated what kind of note would get the beat. Up until now, every meter signature you've seen has had a four on the bottom, meaning that the basic unit of time is the quarter note.

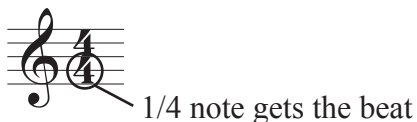

This is true for “simple” meters. However, we now going to consider what is called a “compound” meter, where things are somewhat different. Specifically, I want to look at 6/8, the most common compound meter.

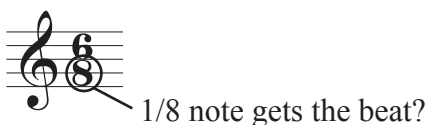

The eight on the bottom of the time signature implies that eighth notes should get the beat. This, however, is a lie! Or, at least, it's not the whole truth.

Counting it slowly, in six

If we are going very slowly in 6/8, it is possible to count out six beats, just like you would expect, with a count for each eighth note.

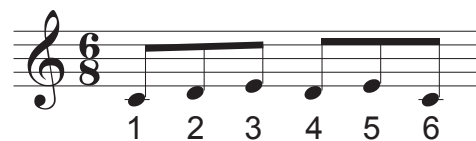

Counting in two

However, in 6/8 there is a sense that the measure also breaks into two halves.



These halves are usually felt as the real beats in 6/8 -- it's like 2/4 that's been subdivided into groups of three, or triplets.

We could re-number these beats as 1 and 2, and subdivide the triplet parts with “+ a”

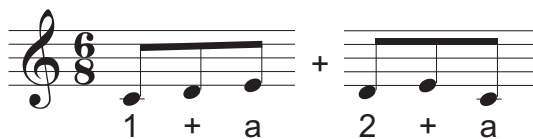

(This “1 + a” system will only work as long as we have no values shorter than an eighth note. If sixteenth notes are introduced into the mix we'll get into trouble!)

If you think about it I bet you can come up with a lot of music that has this triplet feeling - for instance, the “Mr. Softee” theme that blares from ice cream trucks throughout New York City begins in 6/8.

The cream - i - est dream - i - est soft ice cream you get from Mis - ter Sof - tee

Other options - 9/8 and 12/8

We said that 6/8 is like a 2/4 that has been broken into triplet-like beats. We can have a triplety 3/4 and 4/4 as well. 9/8 is a three-beat measure made of triplets, and 12/8 is a four-beat measure.

1 + a 2 + a 3 + a

1 + a 2 + a 3 + a 4 + a

Chapter 11 - Minor Scales

It is time to delve into the dark and mysterious world of the minor scale. Here's C "natural" minor drawn on the piano keyboard:

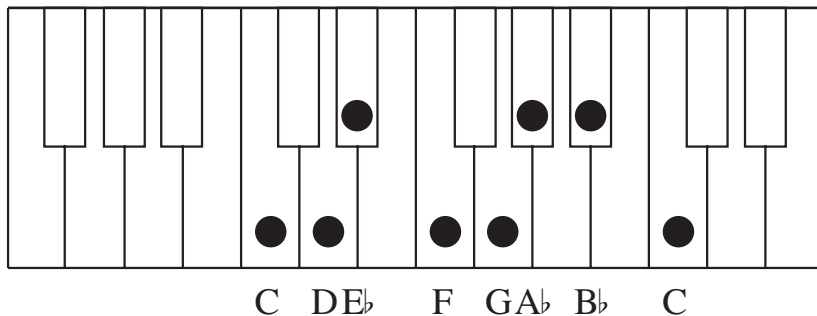

You could learn the shape of the scale by memorizing another sequence of step-sizes -- in this case it would be "WHW \hat{H} WW." However, I don't think that's the best approach to building minor scales. The pattern is hard to memorize and we'll just have to alter it when we get into the three "flavors" of minor.

In my opinion it is easiest to learn the minor scale as a transformation of the major. Start with a major scale and then lower the third, sixth, and seventh scale degrees.

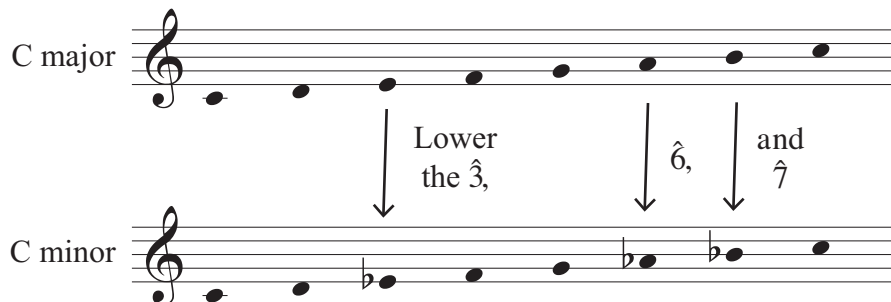

If the major version has notes with no accidentals, we'll add flats. But if the major version has sharps, we'll simply take the sharps away.

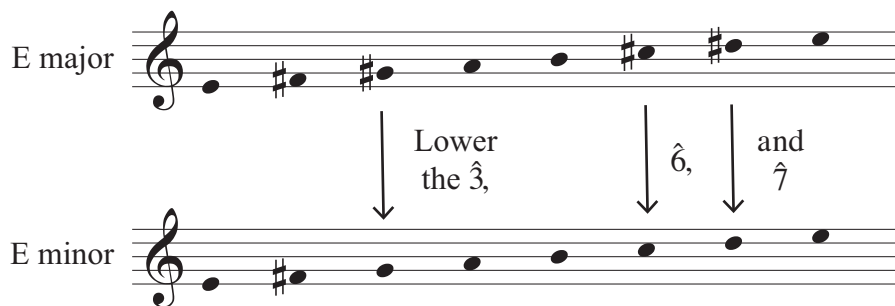

The minor scale that we've learned thus far is called the **natural minor**, and you should think of it as the standard, referential version of the minor scale. However, there are two variants that are traditionally taught in theory class.

Harmonic minor

There are certain situations where you don't want your seventh scale-degree (or "leading tone") to be a whole step below the top of the scale. You want it to be closer, a half-step below, like in the major scale. In the harmonic minor scale you raise the seventh scale-degree back up, and it leaves a funny gap between $\hat{6}$ and $\hat{7}$.

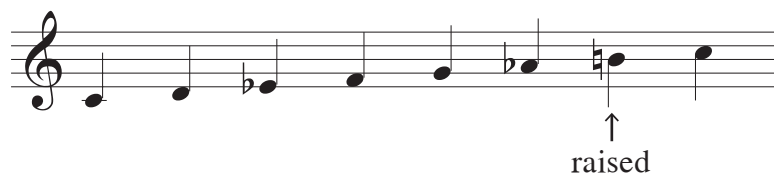

Here I marked my B with a natural sign to draw attention to the fact that it is not flatted. It's probably a good idea to do that with all of these altered scale degrees.

Melodic minor

Melodic minor is different when it is ascending and when it is descending. When it is going up, the sixth and seventh scale degrees are raised, as if it were a major scale. On the way down, however, the sixth and seventh are lowered, like with the natural minor.

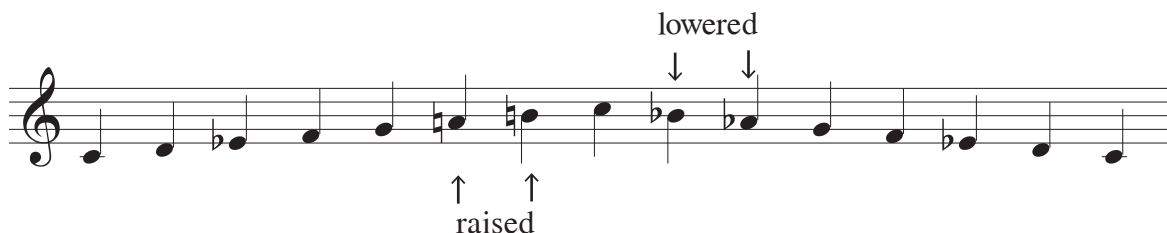

The TRUTH about these variants

I guess it is a little useful to practice these other versions of the minor scale. The reason we study them is that the minor scale isn't really as fixed and stable as the major. You should really think of the sixth and seventh scale degrees as somewhat slippery and variable -- we'll raise them to be like the major scale in some situations and leave them lowered in others.

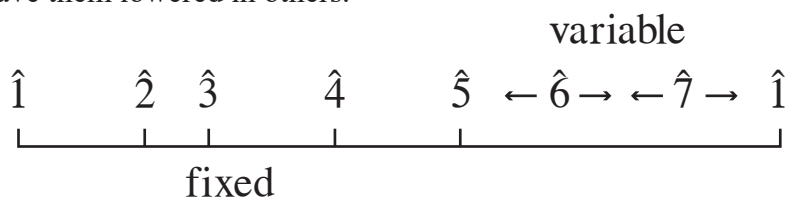

Key Signatures and the Relative Minor

It turns out that major and minor scales lock together in a certain pattern. A minor, for instance, uses all white notes just like C major, only it starts on A.

A minor	A	B	C	D	E	F	G	A
C major	C	D	E	F	G	A	B	C



If you start on a major key and count down (from the top) to the sixth scale degree, you've found the starting point of that key's "relative minor."

					6	7	8
					←	←	
C	D	E	F	G	A	B	C
							relative minor

You can also start by thinking of a minor scale and then counting up a minor third to the relative major.

	1	2	3				
	←	←					
A	B	C	D	E	F	G	A
							relative major

Thus, every key signature on our circle of fifths can serve double duty. It not only represents a major key, but a minor key as well. I'll fill out the very top of the circle here with both the major and minor key labels.

		C major	
			
F major		A minor	G major
			
D minor			E minor

See if you can construct a circle of fifths with all of the relative minors! Note how the minor keys are also related by fifths, just like the majors.

...and here is a complete minor circle of fifths, for your reference.

D minor

A minor

E minor

G minor

B minor

C minor

F# minor

F minor

A# minor

C# minor

B♭ minor

D# minor

G# minor

A♭ minor

D♭ minor

G minor

C minor

F minor

Chapter 12 - The Fancy Note Names

Up until this point we've referred to the notes in the scale mostly with scale-degree numbers, like $\hat{1}$ $\hat{2}$ $\hat{3}$ and so on. The different parts of the scale have other traditional names, as well, and it is time we learned them.

$\hat{1}$, the tonic

The bottom and top of the scale are known as the tonic, and this is the most important tone in the key. It is not only our starting point and the name of the scale, but it is the "home note," the most stable and grounded-sounding pitch. Most simple melodies end on the tonic - it is like the period at the end of a sentence.

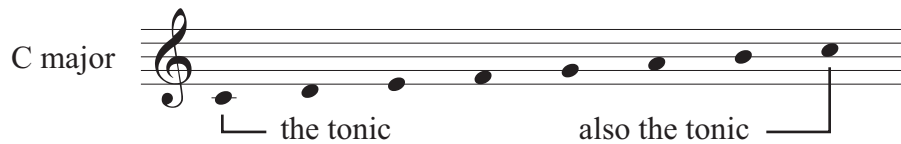

$\hat{5}$, the dominant

Next to the tonic, the dominant is our next-most stable reference point. When working by ear it can be easy to confuse the two tones, because they have a similar quality.



$\hat{4}$, the subdominant

It may seem obvious that the subdominant is so-called because it is a step below the dominant. However, some would argue that in calling it a subdominant we are actually counting a fifth down from the tonic, just as the dominant is a fifth up.

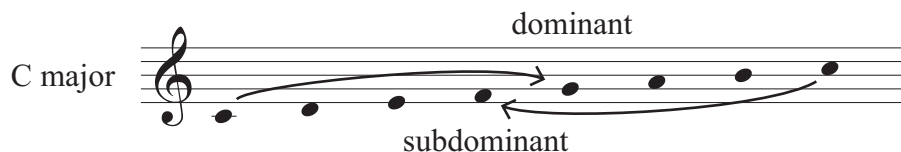

$\hat{7}$, the leading tone

The note just below the tonic is called the leading tone, because it wants to connect to tonic in a “ti-do” figure.

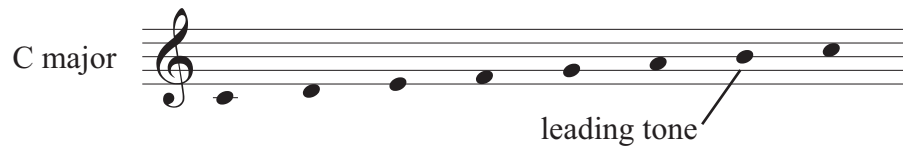

Note that it has to be a half-step below tonic in order to be a proper leading tone - if it is a whole step below (as in a natural minor scale) we call it the **subtonic**.

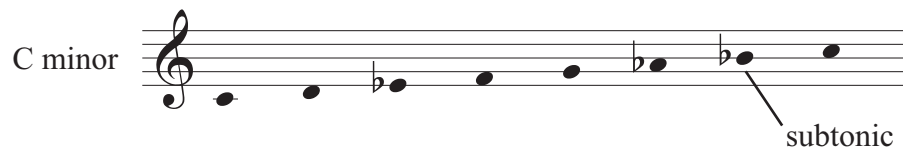

$\hat{2}$, the supertonic

This is just the note above the tonic.



$\hat{3}$ and $\hat{6}$, mediant and submediant

That just leaves the third and sixth scale degrees. We'll climb up to $\hat{3}$ and call that the mediant, and climb the same distance down to $\hat{6}$ and call it the submediant.

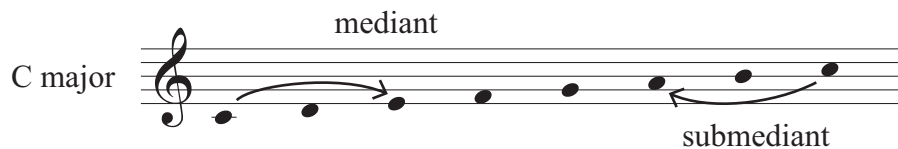

Chapter 13 - Triads

You are probably aware that most music involves **chords**, combinations of notes that stack up into a nice blended sound. The most common type of chord in tonal music is the **triad**, a configuration of three notes in a familiar pattern.

In their simplest form these triads make a “gapped” shape, hitting every other note in the scale. On the piano this fits comfortably under one hand, and it makes a line-line-line or space-space-space figure on the musical staff.

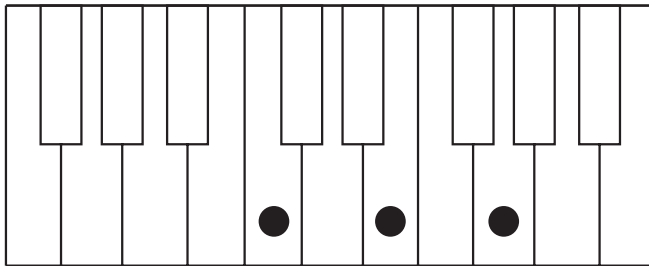

C major triad

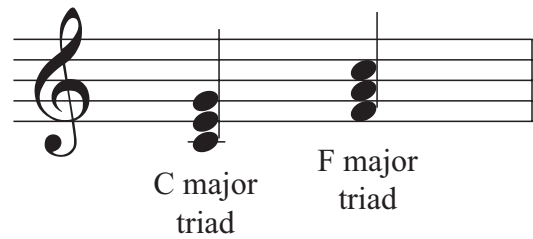

C major triad

F major triad

So, the fastest way to make some common triads would be to think of one of our scales, either major or minor. Grab the $\hat{1}$, $\hat{3}$, and $\hat{5}$ of that scale and boom, you’ve made the corresponding triad. We call these notes the *root*, *third*, and *fifth* of the triad.

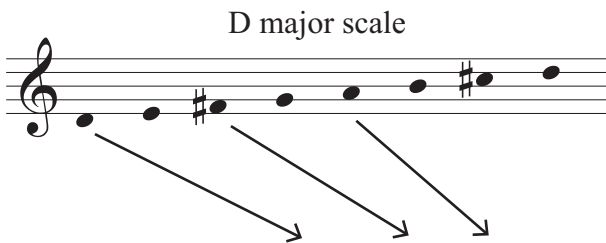

D major scale

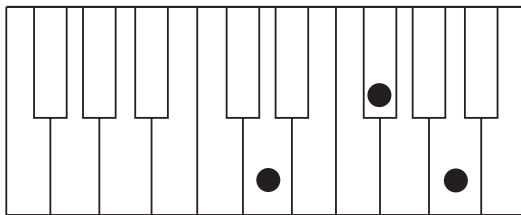

$\hat{1}$, $\hat{3}$, and $\hat{5}$ make a D major triad

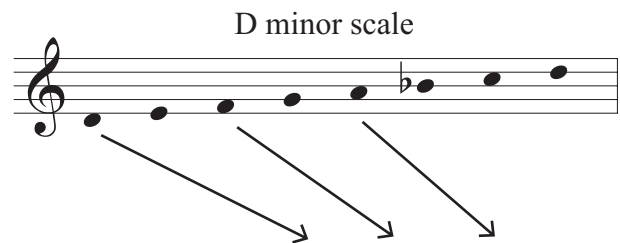

D minor scale

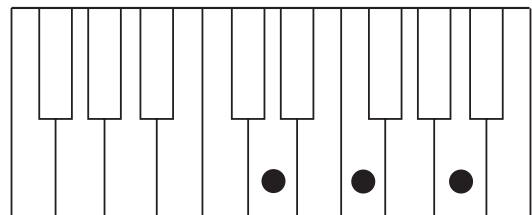

$\hat{1}$, $\hat{3}$, and $\hat{5}$ make a D minor triad

So that’s a quick and easy method for making a few triads, but it’s not enough! There are some that do not correspond to the beginning of a familiar scale. We need to learn how to construct all possible triads.

In order to do that, we need to learn the **intervallic shapes** of the four different kinds of triad.

Thirds

Triads are made of *thirds*. A third is so-called because it extends over three notes of the scale, and it takes up three positions in the musical staff.

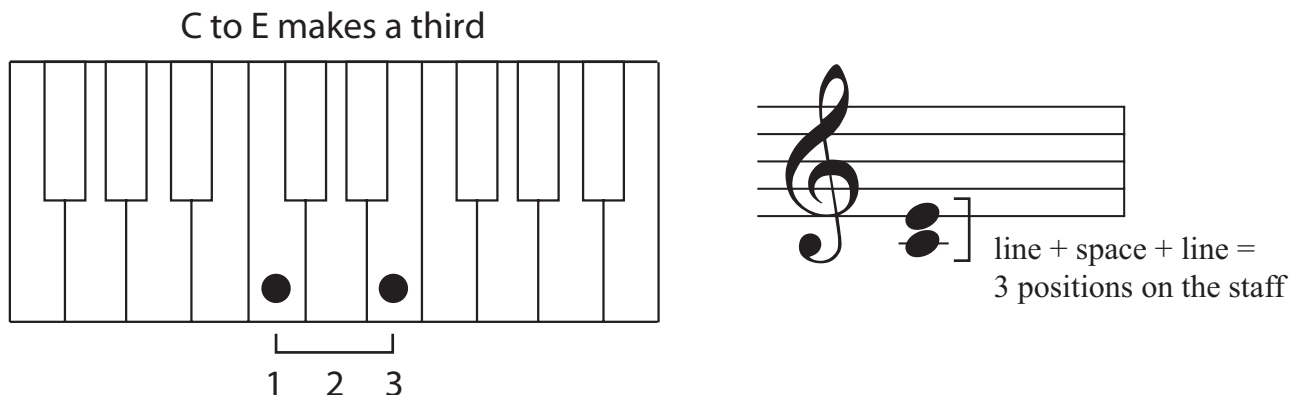

Major Thirds

C to E is a **major third**. It spans the first three notes of the C major scale and it is the bottom part of a C major triad.

The precise size of a major third could be described as **two whole steps** or **four half steps**.

Minor Thirds

Now let's imagine that we are generating a C minor triad, from the C minor scale. Our first two notes will be C and E \flat , and the interval will be a little smaller.

The precise size of a minor third could be described as **whole step plus half step** or **three half steps**.

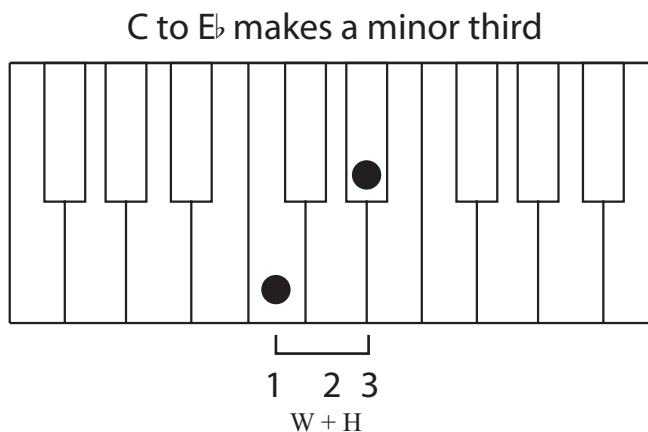

Major Triads

Of course the triad involves two thirds, stacked on top of one another.

The major triad has a major third on the bottom (between the root and the third) and a minor third on top (between the third and the fifth.)

C major triad

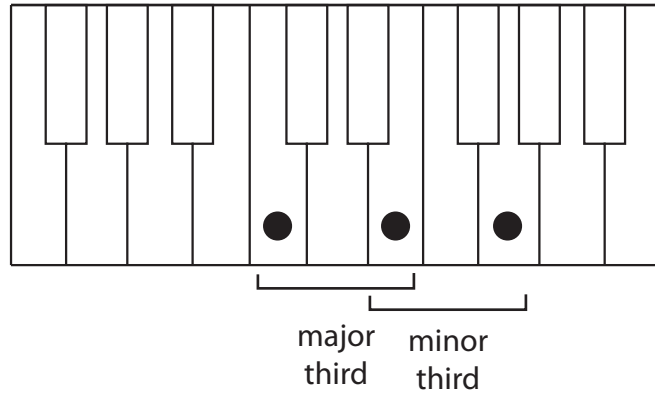
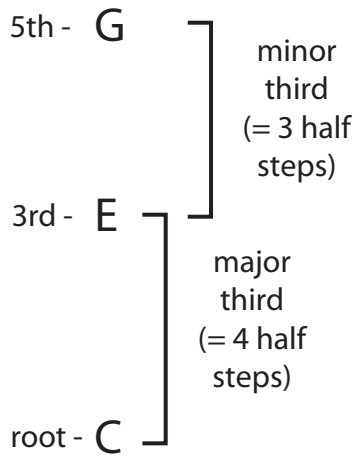

Minor Triads

The minor triad has a minor third on the bottom (from root to third) and a major third on top (from third to fifth).

C minor triad

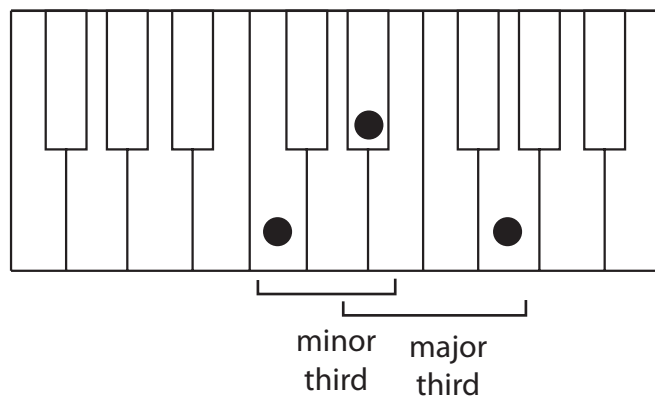
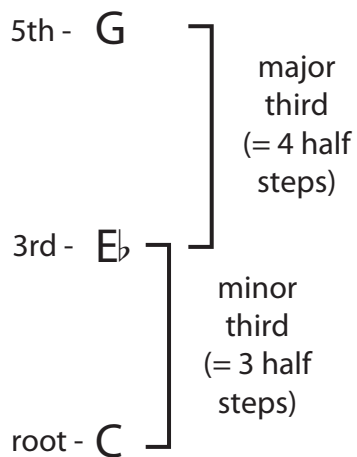

For either the major or the minor the distance from bottom to top will be an interval called a **perfect fifth**. It should span a total of 7 half steps. At this stage you probably don't need to worry about the fifth - if you make your thirds correctly it should work out this way every time.

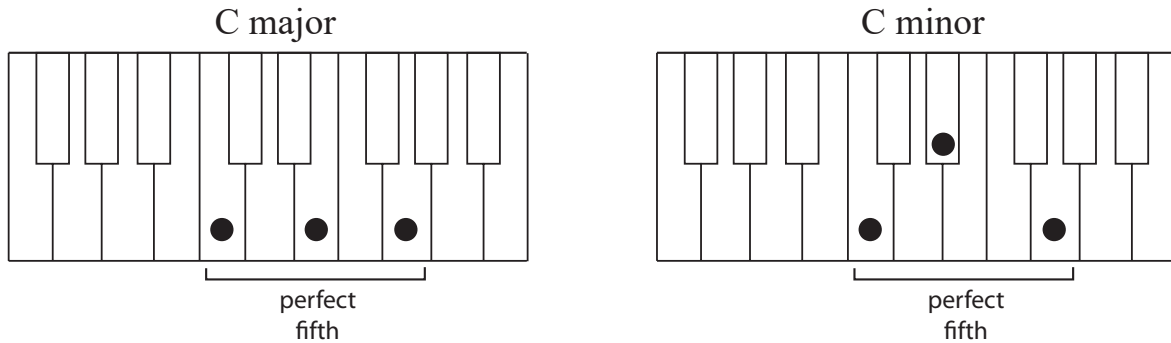

Diminished and Augmented Triads

There are two more kinds of triad that are a little less common.

The **diminished triad** stacks two minor thirds on top of each other.

C diminished triad

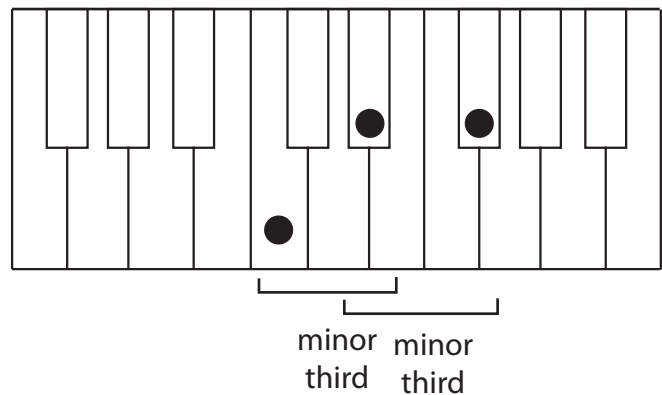
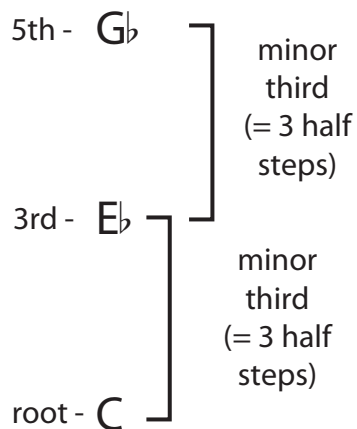

The outside interval will be a **diminished fifth**, which spans 6 half steps. Unlike the perfect fifth which is super stable, the diminished fifth is fairly dissonant and unstable, and it gives the diminished triad a tense and unstable sound.

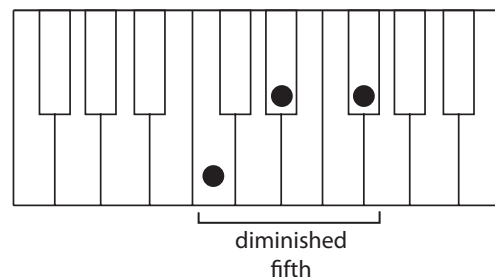

Augmented triads stack two major thirds. The outside interval will be an **augmented fifth** (= 8 half steps).

C augmented triad

5th - G#

major third

3rd - E

major third

root - C

major third

major third

augmented fifth

Interestingly, the augmented triad isn't very dissonant, but it is pretty rare in tonal music. Perhaps this is because it is impossible to make one with the notes from a major or natural minor scale. The only way we can make an augmented triad from one of our scales is to combine $\hat{3}$, $\hat{5}$ and $\hat{7}$ from the harmonic minor.

C "harmonic" minor

$\hat{3}$, $\hat{5}$, and $\hat{7}$ make E_b augmented triad

Spelling Rules for Triads

Make sure you are always “skipping over” a letter name as you go from note to note. This will make the familiar gapped shape with thirds that we’ve been talking about.

Spelling a C minor triad

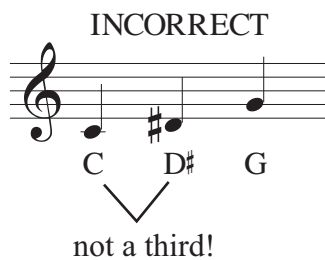
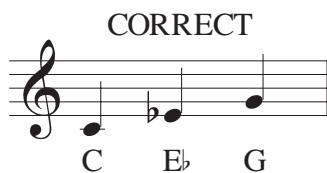

Also, we will *almost never* mix sharps and flats in any of these triads.

Based on everything we’ve learned so far, there is only one exception! B \flat augmented has a B \flat on the bottom and an F \sharp on top.



Chapter 14 - Intervals

Some people would start your theory education by teaching you how to make every kind of interval, right off the bat. This seems reasonable, since everything else we want to make (like scales and chords) are made of intervals, so we might as well start with these elemental units and build from there.

However, since we've put off the subject for this long, you can tell that I don't quite agree. The ability to jump an arbitrary distance from note to note requires an intimate knowledge of musical space. By working on familiar structures like scales and triads, we've built up that knowledge. Now we are ready!

An **interval** refers to the distance between two notes.

The distance between note-names or staff lines

In the most basic sense intervals are referred to by how many note-names they span or how many positions on the staff they take up. "Seconds" move from one note-name to the next one, "thirds" cover three note names and three positions on the staff, "fourths" span four, and so on.

$B\flat \rightarrow B\flat$

The distance of a note to the same note should maybe be called a "first." Except you don't say first, you call it a "*unison*"

(a bunch of seconds)

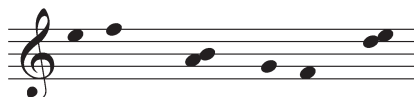

$C \rightarrow D$

The distance from one note to the next name or staff line is a *second*. Often we say "step" instead of second.

(a bunch of thirds)

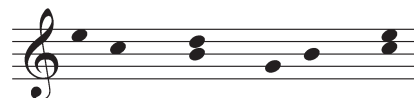

Ⓒ D Ⓔ

Skipping over one note makes a *third*.

(a bunch of fourths)

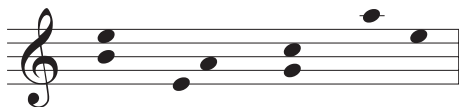

Ⓒ D E Ⓕ

A *fourth* spans four letter-names in total.

and so on...

The **qualities** of intervals - major + minor, augmented + diminished

Most of the time these generic interval names (like third, fourth and fifth) aren't specific enough for our needs. We need to be able to specify the exact size and sound of these intervals by indicating their **quality**.

For instance, we are already aware that thirds can come in two different sizes. C to E makes a larger size called a *major* third. It sounds relatively bright and happy, and it is four half steps across. D to F, however, makes a smaller interval called a *minor* third. It sounds a bit cooler and darker, and it is only three half steps in size.

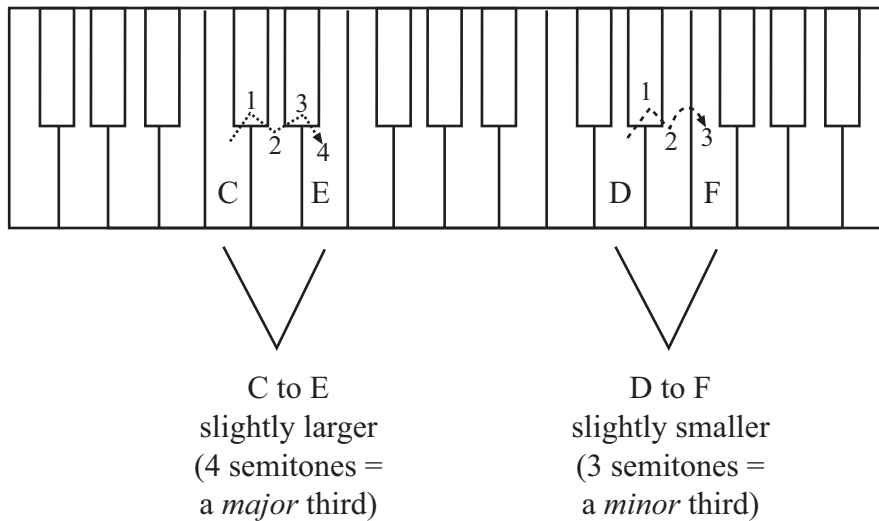

The Perfect Intervals

For the perfect intervals (the unison, fourth, fifth, and octave), there is one size that is considered the normal or most common size. We refer to that as the “perfect” interval. If you make the interval a half-step bigger than normal it is “augmented,” whereas a half-step smaller than normal is “diminished.”

Perfect Intervals: Unison, 4th, 5th, Octave

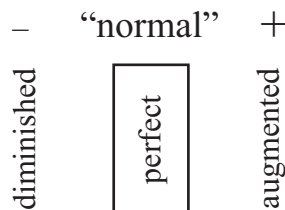

The Imperfect Intervals

The other intervals (2nd, 3rd, 6th, and 7th) are imperfect. Rather than one normal size, they've got a larger version (major) and a smaller one (minor). The major and minor intervals are both very common, but occasionally a major interval is "stretched" even larger, making it augmented, or a minor interval is made smaller or diminished.

Imperfect Intervals: 2nd, 3rd, 6th, 7th

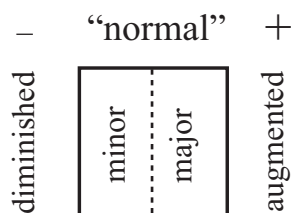

Figuring the size of intervals

I suspect the average musician uses several different ways to calculate the size of intervals.

Size in semitones: The simplest and most efficient way to define an interval is to count how many half-steps or semitones are in it. We saw this in action on the previous page when we noted that a minor third has 3 semitones and a major third has 4. This works well for small intervals, but of course it will become annoying to count up, say, 9 semitones on your piano keyboard.

Scalar segments: An alternative to counting all semitones is to think of the interval as part of a scale. If you imagine that the bottom note in an interval is actually the beginning of a scale, the major scale provides all of the major intervals, and the minor scale provides most of the minor ones.

Intervals in the major scale

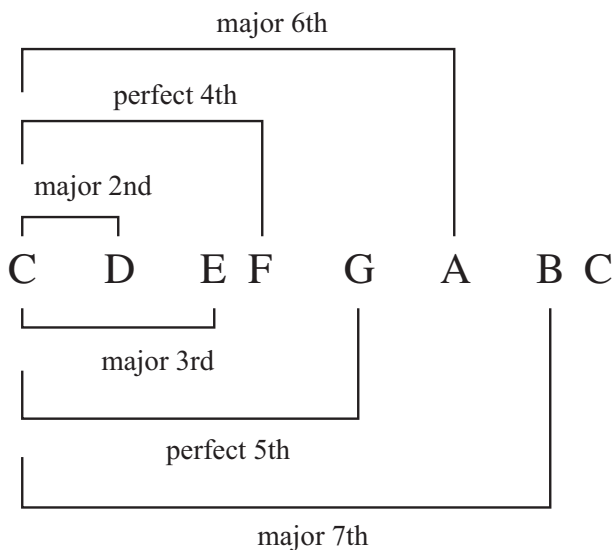



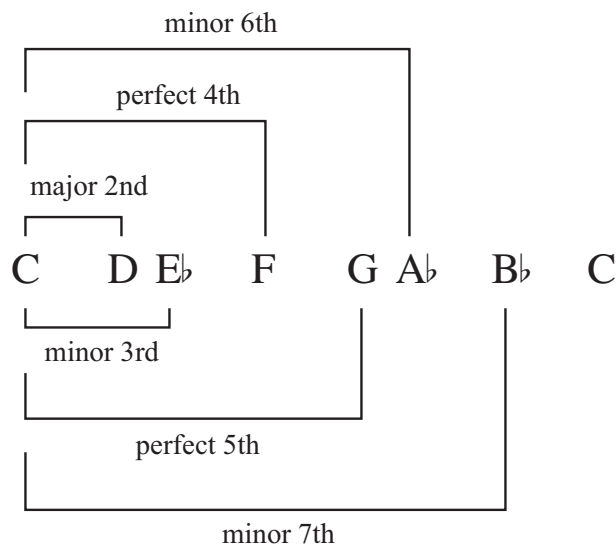

Intervals in the natural minor scale



Guide to small intervals

We've got all we need to start making smaller intervals. Here's a guide to the more common ones.

		SIZE IN SEMITONES				
		1	2	3	4	5
<p>Unison</p> <p>As I've mentioned, this is the distance from one note to the same note. It is theoretically possible to have "augmented unisons" or "diminished unisons," but a more commonsense approach would simply be to call those half steps or semitones.</p>  <p>"aug unison" (half step)</p>						
<p>Minor 2nd</p> <p>a.k.a. half step, semitone</p> 	m2					
<p>Major 2nd</p> <p>a.k.a. whole step</p> 	maj 2nd					
<p>Augmented 2nd</p> <p>This "special" interval is actually somewhat common. It occurs in the harmonic minor scale. It's the same size as a minor 3rd, 3 semitones.</p> 	aug 2nd					
<p>Minor 3rd</p> <p>3 semitones, or W+H. Found in the first three notes of the minor scale.</p> 	minor 3rd					

SIZE IN SEMITONES

1 2 3 4 5 6 7

Major 3rd

4 semitones, or W+W. Found in the first three notes of the major scale.



major 3rd

Perfect 4th

5 semitones, or W+W+H. Found in all scales.



perfect 4th

Augmented 4th / Diminished 5th / Tritone

The interval that spans 6 semitones is famous because it is somewhat difficult to sing. It falls between the P4th and P5th, and it is also known as the “tritone” because it could be built W+W+W. (In reality, though, you will probably think of it in other ways most of the time.)

This is one situation where the way you spell the interval is crucial. (See more on the “enharmonic error” on the next page.) Starting with a P4th and “stretching” it produces an augmented 4th (say, C-F#), whereas starting with a P5th and shrinking it would make a diminished 5th (C-Gb). Note how they look different on the staff:



aug 4th / dim 5th

Perfect 5th

7 semitones, or W+W+H+W. Found in all scales.



perfect 5th

Enharmonic errors

When two differently-spelled notes land on the same key on the piano we say that they are “enharmonically equivalent.” C# and Db are a good example - they are both played on the same black key.

It’s possible to spell *different intervals* that are *the same size*. I’ve already mentioned that the augmented second and the minor third are the same size, as are the augmented fourth and diminished fifth. The bad news is that enharmonically equivalent intervals are not considered interchangeable in tonal theory -- they imply very different contexts (different scales, different melodic continuation, etc.) Some theorists would even argue that they are tuned differently on instruments other than the piano. Thus, if I ask for an augmented fourth and you write a diminished fifth I will probably say that you’ve made “an enharmonic error,” or, if I’m feeling cranky, “that’s not a fourth!”

Avoid this error by paying attention to the very beginning of this chapter. Remember that augmented fourths all look a certain way on the staff and skip a certain number of note-names. Diminished fifths look bigger on the staff, even though they are the same size on the piano.

Inverting your intervals

Imagine you’ve got a major third from F up to A, like so:

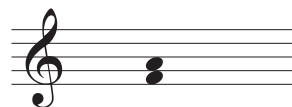

What would happen if the F on the bottom was sent up an octave, so that it’s on top? Or what if we took the A from the top and put it down to the bottom? These repositionings happen all of the time in music, and we refer to it as “inversion.” When we invert an interval in this way we are flipping the notes around into a new configuration.

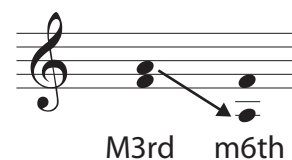
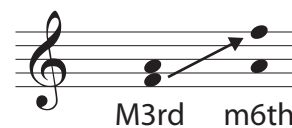

It is easy to predict what an interval will turn into if inverted. First, you must learn which intervals are “opposites” of each other. If you want, you can remember that the numbers add up to nine, though I think it’s more intuitive to just memorize them like so:

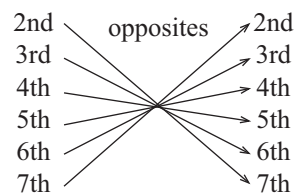

Also, the qualities of inverted intervals will be opposite. Major becomes minor, augmented becomes diminished (but perfect intervals remain perfect.)

major \longleftrightarrow minor
 augmented \longleftrightarrow diminished
 perfect \longleftrightarrow perfect

You could think of the interval and its inversion as two parts that would add up to an octave.



Making larger intervals - using the inversions

Knowing your inversional equivalents is very useful for making larger intervals. It can be confusing to count up a minor 7th (= 10 semitones) from a particular note. Thus, it is useful to know that “any interval up is the same as its inversion down.” While it may be hard to think of a m7th up, it is very easy to think of a M2nd down.

Say you are asked to build a minor 7th up from F. First, calculate the inverted interval (major 2nd) down.



Then, flip that note around so that it's on top.



This is especially useful when you need to make a larger interval that descends from your starting note.

Say you need to make a minor 7th down from C. You can start with a major 2nd up, to D, then flip it around.



Thinking of large intervals as 5th + small interval

Yet one more trick you could use to make large intervals is to count up from the perfect fifth. I definitely do this when dealing with 6ths, since they are just a 5th plus a 2nd. So here is a table that shows you one more way you can think of the large intervals.

minor 6th = perfect 5th + minor 2nd

major 6th = perfect 5th + major 2nd

minor 7th = perfect 5th + minor 3rd

major 7th = perfect 5th + major 3rd

Augmented and diminished intervals as “stretched” and “squished”

Augmented and diminished intervals are perhaps the most tricky to spell. I like to start with a more common interval and “stretch” or “squish” until I get the augmented or diminished version.

First, you’ve got to remember how these intervals relate to “normal” perfect and imperfect ones.

Perfect Intervals: Unison, 4th, 5th, and Octave

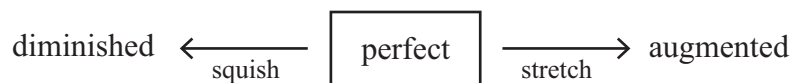

Imperfect Intervals: 2nds, 3rds, 6ths and 7ths



Now, say you were asked to create a somewhat unusual interval, an augmented sixth ascending from F.

First you could start with a major sixth...

... then raise the top note an extra half step for an augmented 6th.

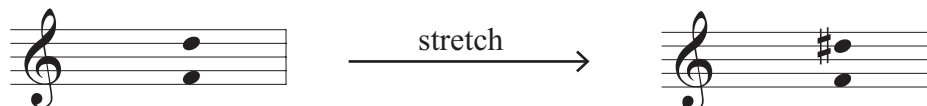

Be careful when making descending intervals, though. You need to push the notes the opposite way in order to “stretch” or “squish”!

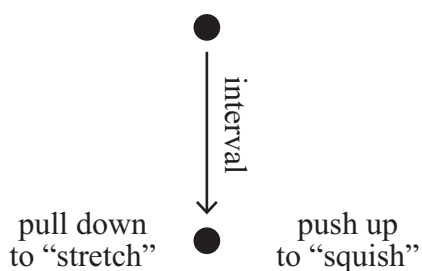

So if you are making a descending diminished fifth from C, create a perfect fifth down and then squish it upwards.

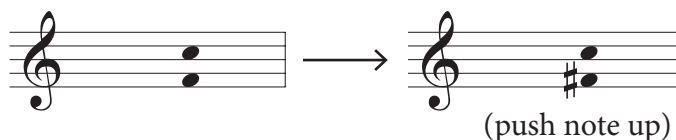

Also, remember you can check your work by inverting. A diminished interval will invert to an augmented one, and vice versa. If you flip that diminished F#-C around it makes an augmented fourth, so we know we did it correctly.



Chapter 15: Diatonic Triads and Roman Numerals

When we speak of **diatonic** triads we mean the chords that fit into the key you are working in. They draw from the notes in the scale and tend to sound fairly “normal” and “typical.” The opposite of diatonic would be **chromatic** - chromatic chords use tones from outside of the scale, and those will tend to have a more complex or surprising effect. Eventually (in Theory II) we will get to play with chromatic chords, but first we need to learn how to make more typical progressions that stay in the key.

So imagine we are working in C major. You probably already know that the C major triad uses scale-degrees $\hat{1}$, $\hat{3}$ and $\hat{5}$, and that simple melodies in C tend to emphasize the tones in this triad.



Now let's imagine that we take that triad shape and just push it up the scale. We'll make a D minor triad, an E minor, F major, and so on. We even get one diminished triad, on B.

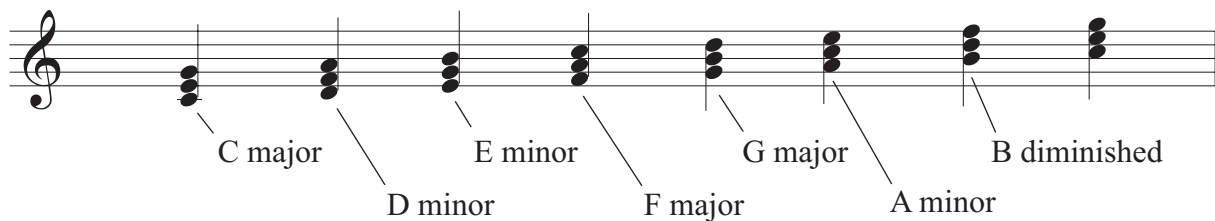

These are our diatonic triads in the key of C major. We will refer to these with some roman numerals, and we'll follow a few conventions to remind ourselves which ones are major, minor, or diminished.

Major triads (I, IV and V) get uppercase roman numerals.

Minor triads (ii, iii, and vi) get lowercase roman numerals.

Our diminished triad (vii^o) is lowercase with a little circle after it.

This pattern holds true for all major scales. For reference I'll lay out the diatonic triads in C major with the roman numerals.

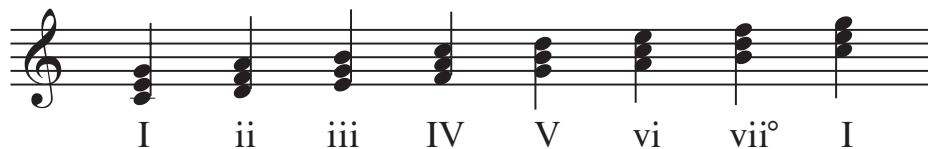

(Not every theory text uses this uppercase and lowercase convention - some indicate all triads in uppercase.)

(Also, we can use our “fancy names” for these triads. I is the tonic triad, V is the dominant, etc.)

Minor Keys

Hopefully you remember that the minor scale is a little more complicated than major. We've already learned three different versions (natural, harmonic and melodic), which differ in their $\hat{6}$ and $\hat{7}$ scale degrees.

Most of our diatonic triads in minor can be derived from the natural minor scale, but a few draw on the raised leading-tone of the so-called harmonic minor.

A set of triads for C minor

Let's start by laying out a set of chords for C minor. I'll put the three flats in the key signature, but the B \flat will be raised and lowered for a few different triads.

i ii° III iv V VI VII vii°

Dealing with the raised leading tone

The raised scale-degree $\hat{7}$ from harmonic minor is usually added to music on a measure-by-measure basis. It's not in the key signature! Here is an example from our melodies anthology which I composed in D minor. Note all of the added C \sharp 's which give me the sound I want. If I were playing along at the piano I would use a major V chord (A C \sharp E) in a lot of these places that emphasize C \sharp .

If you are writing in a very "flatty" key (three flats or more) you may have to add naturals into the music to "unflat" your leading tone. Here is an anthology melody in F minor which adds a few E \natural 's.

Making the Major V

When we practice our roman numerals in minor I'll often set up a key signature that takes care of all of the typical sharps or flats. If a major V is called for, however, you'll have to add a sharp or a natural sign to make it a major triad.

question *answer!*

c: V c: V

Later, when we work on piano progressions I'll frequently remind you to raise your leading tone whenever you build a V in minor.

c: i V i

Using a major V in minor keys is a very common sound. It happens frequently in classical music, traditional folk styles, jazz, early rock n' roll, etc. See if you can play the i-V-i progression shown above with and without the B \flat in there. You'll hear that a i-v-i with G minor (G B \flat D) sounds unusual, maybe a bit "cold" or "Medieval."

More recent rock and pop music tends to avoid the V chord altogether in favor of more fresh-sounding progressions, so major V and minor v are both somewhat rare in minor keys. For the purposes of our studies I will treat major V as though it is always the correct option.

Using VII

If you build a triad on the unraised version of $\hat{7}$ in minor you get a major triad. This is also known as "the subtonic," and in class I may simply call it "major VII." Rock music loves the subtonic, and you may see it in classical music as a remote chord deep in the progression.

c: i VII

Using vii $^\circ$

If you build on the raised leading tone, however, you'll produce a diminished triad. We call this harmony the "leading-tone triad" or just "diminished vii $^\circ$." This modification is very common in classical music, but rare in other styles. We will practice it a little bit - remember that if I ask for a vii $^\circ$ in minor you need to *start by raising your leading tone*.

c: vii $^\circ$

Chapter 16: Triad Inversions

Up until now we've been building our triads in **root position**. We start with the root of the triad, then add a third, and finish with a fifth on top.

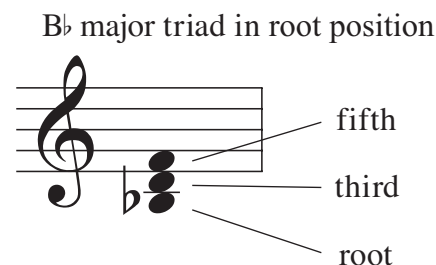

However, this isn't the only way we can do it. There are two ways to flip around or invert the triad to make different shapes. These will have slightly different sounds.

First inversion starts with the third on the bottom..

B \flat major triad in first inversion

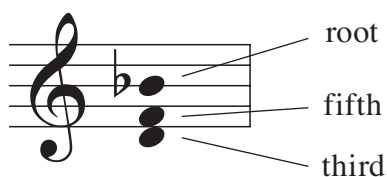

...and **second inversion** starts with the fifth on the bottom..

B \flat major triad in second inversion

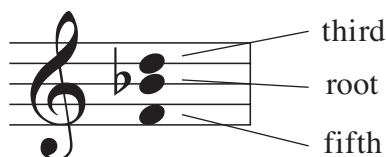

$\frac{5}{3}$, $\frac{6}{3}$, and $\frac{6}{4}$ shapes

For reasons that I hope will make sense later, I am also going to use a second set of terms to refer to our chord inversions. These come from a tradition called figured bass that originates around the year 1600. Figured bass terminology still has an influence on how we analyze classical music in the present day.

Root position = a $\frac{5}{3}$ shape.

We can call our root-position triad a $\frac{5}{3}$ shape, because the little stack of notes makes a fifth and a third. We pronounce this notation as “a five-three shape.”

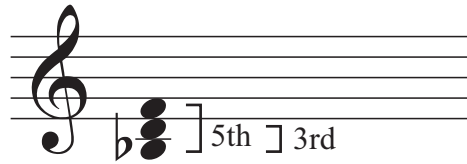

First inversion = a $\frac{6}{3}$ shape.

Our triad in first inversion is a $\frac{6}{3}$ shape, because the distance from bottom to top is a 6th, and bottom-to-middle is a 3rd.



Second inversion = a $\frac{6}{4}$ shape.

Finally, second inversion is a $\frac{6}{4}$ shape, because bottom-to-top is a sixth and bottom-to-middle is a fourth.

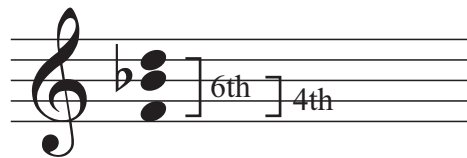

Practicing your inversions

These inversions will probably be pretty easy to make on paper. One useful trick in the beginning will be to sketch the letter-names of the triad above the staff, and then select from those as we stack up our notes.

So, for instance, if I ask you to “make an A major triad in first inversion” you could...

- 1) Sketch out the letter names in the triad above the staff.

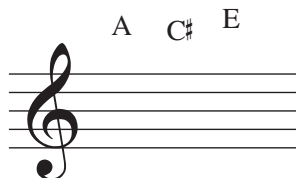

- 2) Select from those notes and stack them up, starting with C#.

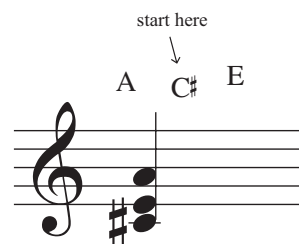

On the piano

However, we also want to practice these at the keyboard, to get comfortable grabbing the different inversions quickly and reliably. To do this, we'll make a pattern that cycles from root position through the inversions and back to root position. Here is the pattern for B-flat major:

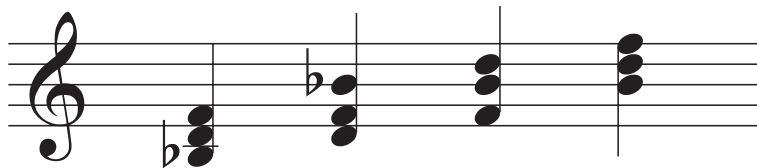

When we play those block chords we will just pick up our hand and move it from inversion to inversion. However, we could also roll through all of it in a smooth motion called arpeggiation. Here is an arpeggiated pattern all notated out.



Actually executing such an arpeggio smoothly can be very tricky, especially for a beginning pianist! Planning out your fingering for each arpeggio can help.

Chapter 17: Getting Started with 4-Voice Progressions

In order to compose or even understand most music, you need to know how to create chord progressions. In classical music this typically means creating harmonies with four parts that obey the rules of counterpoint. While other genres (such as pop and jazz) would be free to break these rules on occasion, learning this skill will help you create smooth and elegant progressions in any context.

The basic setup - “Keyboard Style”

We are going to begin by writing in keyboard style. We’ll have triads in the treble clef (to be played with the right hand) and a bass line in the other clef (for the left hand.)

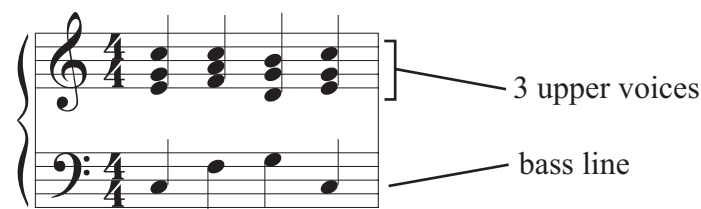

These two parts of the texture behave very differently. The upper voices tend to move from chord to chord in the smoothest way possible. They are also carefully stacked so that they create a homogenous, blended sound. The bass line, on the other hand, will leap around a bit more, and it does not need to “blend” with the top parts.

SATB style

Some theory courses require you to write in SATB style all of the time. SATB stands for soprano, alto, tenor, and bass, and here our four notes will be explicitly divided into four separately-notated voices. The soprano line is stemmed up, the alto is down, tenor up and bass is down.



When you write in SATB style all of our other theoretical concepts are supposed to be the same. Our top three voices (S, A and T) are still supposed to blend together in an upper chord, and their spacing is supposed to be fairly uniform. The bass still gets to wander away from the other parts if it wants.

In my opinion SATB style is much harder to write than keyboard style, at least when you are first starting out. For now we’ll stick to keyboard style so that we can better visualize our triads.

Making your bass line

Once you select the chords in your progression, the bass line is very easy to write. For now, we will write with all chords in root position - this means that the bass line will always cover the root of each harmony.

Three possible bass lines for the same progression

I IV V I I IV V I I IV V I

The upper triad

The upper voices will cover all three tones of the triad. In the beginning we'll write our triads in *close position*, meaning that the notes are stacked as closely together as possible. This triad shape can be inverted or “flipped around” any way you want.

options for upper triad

C: I

Ultimately it is the bass note that determines what inversion this harmony is in. As long as C is in the bass, all three of these options would be considered “root position.” This is why we might want to use our awkward language about $\frac{5}{3}$ shapes, $\frac{6}{3}$ shapes, and $\frac{4}{3}$ shapes to talk about the upper triads.

We could say that this example presents a $\frac{6}{3}$ shape, a $\frac{4}{3}$ shape, and a $\frac{5}{3}$ shape, all over a root in the bass.

Doubling

The upper voices will cover all three tones of the triad and the bass covers the root. Thus one of the tones (the root) ends up being *doubled*, since it appears in both the upper voices and the bass line. There are other possibilities for doubling, but we'll worry about them later.

(for now...)

- 1) Always cover all three tones in the upper voices.
- 2) Always double the root.

complete
triad on
top

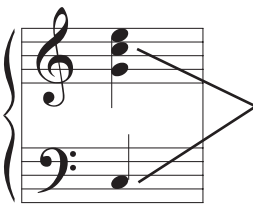

root gets doubled

The diagram shows a grand staff with two staves. The upper staff (treble clef) contains a triad of three notes: G4, B4, and D5. The lower staff (bass clef) contains a single note: G3. A large right-pointing arrow originates from the G4 note in the upper staff and points to the G3 note in the lower staff, with the text 'root gets doubled' written to the right of the arrow. Above the upper staff, the text 'complete triad on top' is centered.

Voice-Leading and the Rules of Counterpoint

Here's the weirdest thing you need to understand about keyboard style. Even though we are planning each chord vertically as we choose different triad shapes, we also have to think of our progression in terms of horizontal lines. The upper three notes represent three different lines, and you have to pay attention to what each one does. We often call each part a "voice" and the art of connecting your chords in a smooth and legal manner is called "voice-leading."

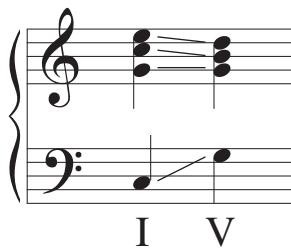

I V

The diagram shows a grand staff with two staves. The upper staff (treble clef) contains two triads. The first triad (I) has notes G4, B4, and D5. The second triad (V) has notes F4, A4, and C5. The lower staff (bass clef) contains two notes: G3 and D4. A right-pointing arrow connects the G4 note of the first triad to the G4 note of the second triad. Another right-pointing arrow connects the B4 note of the first triad to the A4 note of the second triad. A third right-pointing arrow connects the D5 note of the first triad to the C5 note of the second triad. Below the staves, the letters 'I' and 'V' are centered under the first and second chords respectively.

*Here, the top line goes down a step, E - D,
the middle of the chord also steps down, C - B,
and the lowest part of the upper voices stays the same,
on G.*

The bass line goes up a perfect fifth.

(Writing in SATB style makes the voice-leading aspect of your progressions much more explicit! However, it makes everything else harder.)

The #1 Rule of Counterpoint: No Parallel Octaves or Fifths

Counterpoint is the art of combining lines in an elegant and interesting way. In general, we want our lines to sound good together and create a full and lively texture.

Let's imagine that we have two parts and both of them go from C to D.

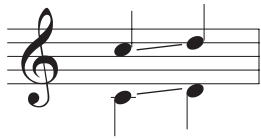

Because the two lines both move up by a whole step, they are said to be in *parallel motion*. These two particular parts are making octaves on each beat - these *parallel octaves* are against the rules of good counterpoint.

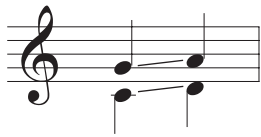

Parallel fifths are also banned.

No fifths or octaves by contrary motion

A related rule is that you can't make two fifths or octaves by contrary motion, either.

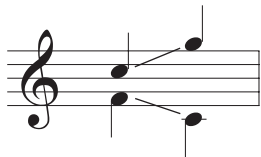

These two parts fly out in opposite directions, which is called *contrary motion*. Because they make a perfect fifth (F-C) and then another one (C-G), this is also banned.

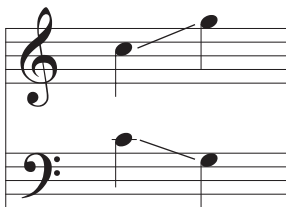

The same is true if they make octaves by contrary motion.

Why?

We want our lines to maintain a certain amount of independence so that we hear a nice, full texture with lots of movement in it. Most of the time as parts “do their own thing” this is not a problem. However, when parts sync up in parallel 5ths or 8ves the ear tends to fuse them together, so that they sound like one moving thing rather than two. Compare these two pairs of lines:

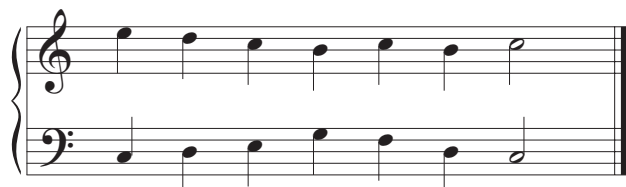

These two voices are written with good counterpoint. I could illustrate the effect of two independent lines like so:

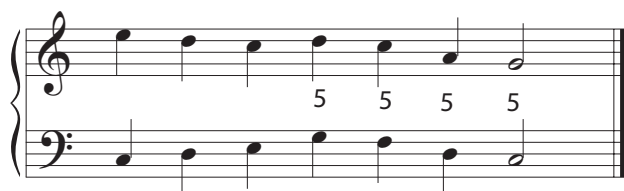
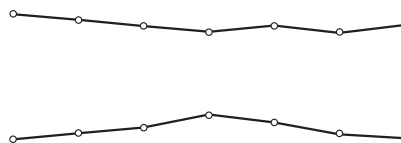

Here I’ve replaced the ending with a bunch of parallel fifths. This “collapses” into a thin and somewhat crude-sounding texture.

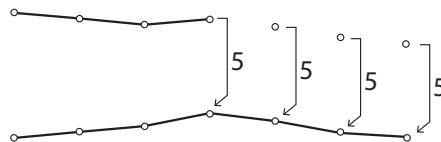

Because of their acoustic properties (in particular, their close relationship to the overtone series) fifths and octaves tend to have this fusing effect. Other intervals such as thirds and sixths tend to sound much fuller. Compare the parallel thirds and sixths that make up this counterpoint:

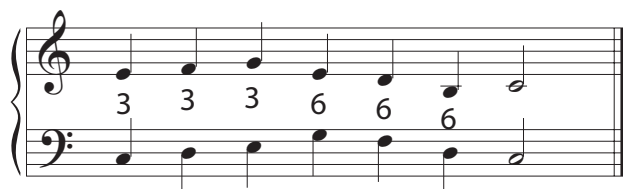

This passage would be considered legal, because thirds and sixths can support the sense of two independent lines, even when they move in parallel motion.

Parallels in the Progressions

Believe it or not, you are responsible for making sure that no two voices make parallel octaves or fifths within your entire progression. There are six different combinations of parts to look at!

The image displays six musical diagrams, arranged in two rows of three, each showing a progression from a tonic chord (I) to a dominant chord (V). Each diagram consists of a grand staff with a treble clef and a bass clef. The chords are represented by block letters 'I' and 'V' below the notes. The diagrams illustrate different voice leading patterns between the two chords:

- Diagram 1 (Top Left):** Treble clef: I (C4, E4, G4) to V (C4, E4, G4). Bass clef: I (C3) to V (C3). This shows parallel motion in both voices.
- Diagram 2 (Top Middle):** Treble clef: I (C4, E4, G4) to V (C4, E4, G4). Bass clef: I (C3) to V (E3). This shows parallel motion in the bass.
- Diagram 3 (Top Right):** Treble clef: I (C4, E4, G4) to V (C4, E4, G4). Bass clef: I (C3) to V (G2). This shows parallel motion in the bass.
- Diagram 4 (Bottom Left):** Treble clef: I (C4, E4, G4) to V (C4, E4, G4). Bass clef: I (C3) to V (E3). This shows parallel motion in the bass.
- Diagram 5 (Bottom Middle):** Treble clef: I (C4, E4, G4) to V (C4, E4, G4). Bass clef: I (C3) to V (G2). This shows parallel motion in the bass.
- Diagram 6 (Bottom Right):** Treble clef: I (C4, E4, G4) to V (C4, E4, G4). Bass clef: I (C3) to V (G2). This shows parallel motion in the bass.

However, for now you don't need to worry. I'll show you some basic procedures you can follow to make perfect connections every time. Later we'll learn how to systematically scan for these parallels.

Chapter 18: I-V-I Progressions

We are going to carefully build up a vocabulary of chord progressions. Each step on the way will introduce both a new harmonic function and new voice-leading requirements (i.e. new things you need to remember when you connect the chords).

This chapter focuses mainly on the V chord, but the voice-leading procedures we will learn apply to any two chords related by a fourth or fifth.

The V chord is the most important harmony in the tonal universe besides I. To get started writing V-I progressions in 4 voices, there are 2 “procedures” you need to learn.

The Common-Tone Procedure

The absolute smoothest and simplest way to connect chords related by fourth or fifth is to take a common tone. It’s easy. Let’s start by making a I-V progression in C major.

- a) Build your first chord with a complete triad on top (flipped any way you like) and a note in the bass.

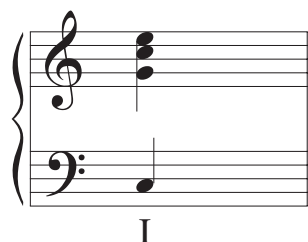

- b) Figure out which note belongs to both the I and the V chord. This is the common tone. If you are not yet confident with your diatonic triads you could spell out both triads above the staff.

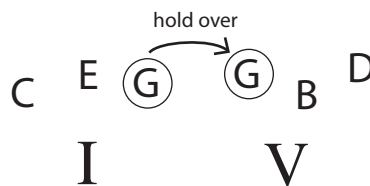

- c) Hold the common tone over in whatever voice it happens to be in.

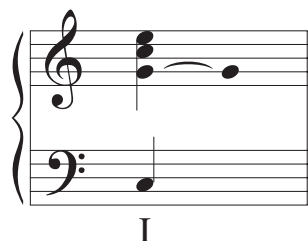

- d) Connect the other 2 upper voices to tones in the V chord. Both will slide either up or down by step. Make the bass cover the root and you are done!



The “Next-Closest” V Chord

The common-tone procedure makes the closest or smoothest possible connection between I and V. However, you may not want this particular voice leading. For instance, perhaps you want your top line to go up from C to D, instead of down. In this case you can make a “next-closest” connection in which *all upper parts move a third or less*.

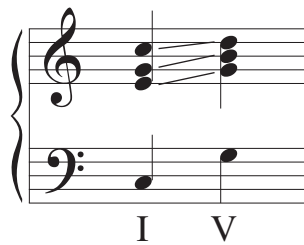

Ultimately I think this “procedure” simply involves putting down your new chord and inspecting it carefully to see that it moves by a third or less.

Moving more than a third = wrong

If you choose a connection in which one of the upper voices moves more than a third, it’s going to make a bad parallels or bad contrary motion with the bass. We’ll talk more about these rules later, but in the meantime you should just take my word for it and avoid letting the upper voices move by 4th or 5th.

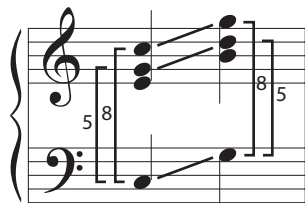

*moving too much causes
parallel 5ths and 8ves*

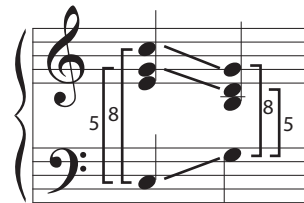

*moving too much causes
5ths and 8ves by contrary
motion*

Other common progressions you can make

These connections can also be used to make I-IV-I's as well as "circle-of-fifths" progressions like vi-ii-V-I.

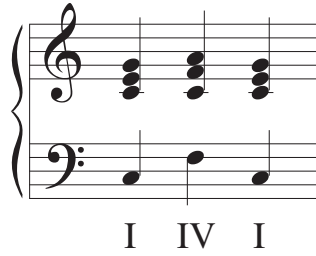

Musical notation showing a progression of three chords: I, IV, and I. The notation is in a grand staff (treble and bass clefs). The bass line consists of three quarter notes: C, F, and C. The treble line consists of three triads: C major (C-E-G), F major (F-A-C), and C major (C-E-G).

I IV I

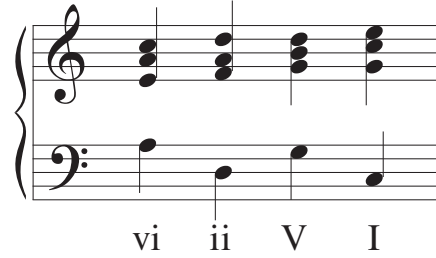

Musical notation showing a progression of four chords: vi, ii, V, and I. The notation is in a grand staff (treble and bass clefs). The bass line consists of four quarter notes: F, C, G, and C. The treble line consists of four triads: F major (F-A-C), C minor (C-Eb-G), G major (G-B-D), and C major (C-E-G).

vi ii V I

Chapter 19: Using ii and IV chords.

In this chapter we'll start using some chords that commonly lead to V, namely the ii and IV chords. This will introduce a new voice-leading challenge, with bass lines that move by step.

I-IV-I: The Plagal Progression

In our previous unit we learned about progressions in which the bass moves by fourth or fifth. The most common of these is I-V-I, but we also practiced a few I-IV-I's. I-IV-I is a more gentle "lifting up" from the tonic that often sounds a little churchy.

I-IV-I as a "lifting up" from I

I IV I

When you end a phrase with IV-I it is known as a "plagal cadence," and we are going to call any I-IV-I motion **the plagal progression**. You can make plagal progressions with the common-tone technique or do a next-closest connection in which the parts move by a third or less.

common-tone connection

I IV I

next-closest connection

I IV I

IV Leading to V

IV also has another extremely important function as a stepping-stone to V. Using it in this way will allow us to stretch out our progressions and make more interesting music. We can create a little flowchart like so to demonstrate the path we are taking to the I.



New Voice-Leading Relationship: The “Step Zone”

As we move from IV to V, our bass moves up by a whole step. We’ll connect the chords by following a simple rule: **When the bass moves up or down by step, make your upper parts move in the opposite direction.** As the bass steps up, we’ll slide down to our nearest V chord.

The diagram shows a piano accompaniment for the transition from IV to V. The bass line consists of four notes: F, G, A, B. The upper voices (treble clef) consist of four chords: C4-E4-G4, C4-E4-G4, C4-E4-G4, and B3-D4-F4. An arrow labeled "upper voices go down" points to the right above the treble staff. Another arrow labeled "when bass steps up" points to the right below the bass staff.

Failure to do this will cause massive parallels.

The diagram shows a piano accompaniment for the transition from IV to V. The bass line consists of four notes: F, G, A, B. The upper voices (treble clef) consist of four chords: C4-E4-G4, D4-F4-A4, E4-G4-B4, and F4-A4-C5. The annotation "parallel 5ths and 8ves" is written above the treble staff.

I call this relationship (and the contrary-motion technique to handle it) the “step zone.” We’ll find out later that it is not an iron rule by any means, but for now moving in the opposite direction is a handy procedure to make a safe and fast connection.

With a I-IV-V-I pattern, there are two different kinds of connections you will make. For practice, we’ll scan our bass line and put a little bracket on the step zone. The other connections are all common-tone/next-closest, because the bass is moving by a fourth or a fifth.

The diagram shows a bass line for a I-IV-V-I pattern in C major. The notes are C, F, G, C. Above the staff, two arrows point to the F and G notes, each labeled "common tone or next closest". Below the staff, a bracket spans the F and G notes, labeled "step zone". The chord symbols C: I, IV, V, I are written below the notes.

ii Leading to V

The ii chord is another common stepping-stone to V. It is said that the ii and IV are somewhat interchangeable because they share two tones, like so:

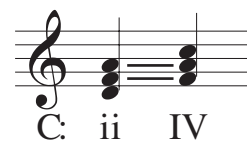

Together they form a little family on our flow chart. Theorists refer to both of these chords as **subdominant harmonies**. (Or, if they are being fussy and want to reserve “subdominant” for IV, they call them **predominants**.)

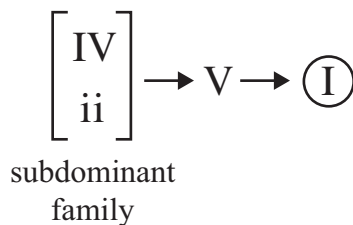

Step Zone with ii

In a I-ii-V-I progression, the step zone lies between the first two harmonies. Be sure to shift downward. The other connections can all be made with the common-tone or next-closest techniques, since the bass is moving by fourth or fifth.

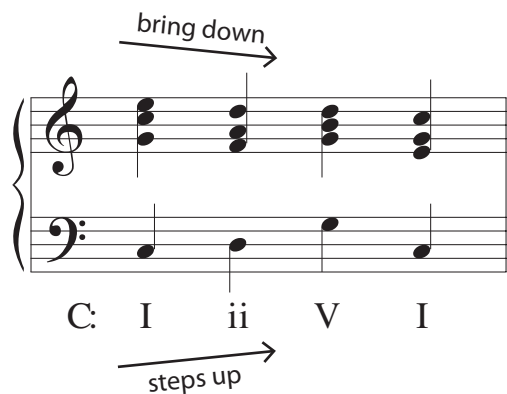
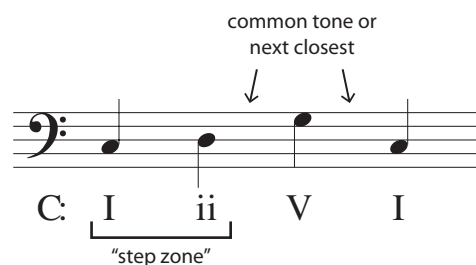

Don't use ii° in minor

In minor keys the ii° triad is diminished, and classical composers thought that it sounded harsh. Thus, for now you should avoid using the ii° to V in minor. (The solution is to use ii° in first-inversion, like i - ii°⁶ - V - i.)

Chapter 20: Progressions that move by third

In chapters 18 and 19 we covered what to do when your bass line moves by fourth or fifth and what to do when it moves by step. Last but not least are situations where your bass moves by a third or sixth. Happily, the solution is super easy.

Two common tones

Let's pretend that we are in the key of C major and we want to go from I down to vi. Our bass goes C-A, and we sketch out a C major and A minor triad above the staff. It is easy to see that these two chords are almost the same, sharing two common tones.

C: I vi

We **hold over the common tones and move the remaining tone by step**, and that's it! We have a super-smooth connection that is "proper" counterpoint.

C: I vi

That's pretty much your only option

If you bring your upper voices down by a third, that's parallel motion with the bass, creating parallel octaves and fifths.

parallel
5ths + 8ves

C: I vi

If you make the bass jump up by a sixth, it doesn't fix it. Instead it makes successive octaves and fifths by contrary motion, which are basically the same thing.

5ths + 8ves
by contrary
motion
with bass
(parallel 5ths
on top)

C: I vi

Finally, you might say “OK, I won’t bring my chord down by a third, I’ll flip it upwards instead.” This is *maybe* legal, but it moves a lot!

There is another textbooky rule (sometimes called “voice crossing”) that argues that you shouldn’t make that E-A part go higher than the G.

I am not wholly convinced that this is an important rule, but it is safe to say that **you should just take your two common tones**, unless you have a good reason to jump like this.

C: I vi

maybe OK,
but jumps a lot

“voice
crossing”?

Expanding our flowchart

Now that we know more kinds of chord connections we can really explore our roman numeral flowchart. When we last looked at the flowchart it was a somewhat boring sequence of subdominant, dominant, and then tonic.

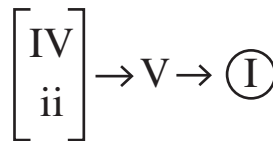

the subdominant
family

Also, we sometimes make a direct I-IV-I connection which I call the “plagal progression.”

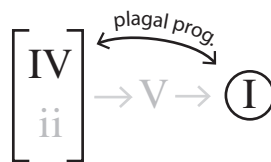

Extending the chain of fifths, backwards

One of the progressions we’ve already practiced from the flowchart is ii-V-I. It could be called a *circle-of-fifths progression*, because each step forward in the sequence goes down a fifth. However, for the sake of having a playable bass line it is normal to make a zig-zag pattern that goes up a fourth and down a fifth, or vice-versa.

C: ii V I

Adding the submediant (vi)

We could expand this sequence backwards and do vi-ii-V-I. The submediant is a relatively remote harmony in our flowchart that does come up every now and then in tonal music.

C: vi ii V I

$$vi \rightarrow \begin{bmatrix} IV \\ ii \end{bmatrix} \rightarrow V \rightarrow \textcircled{I}$$

Since we can now maneuver by third it is easy for us to make a I-vi-ii-V-I progression. Or we could continue to go in thirds and use IV as our subdominant, making the “heart and soul” progression.

C: I vi ii V I

$$vi \rightarrow \begin{bmatrix} IV \\ ii \end{bmatrix} \rightarrow V \rightarrow \textcircled{I}$$

C: I vi IV V I

$$vi \rightarrow \begin{bmatrix} IV \\ ii \end{bmatrix} \rightarrow V \rightarrow \textcircled{I}$$

Adding the mediant (iii)

Expanding the flowchart even further backwards along the chain of fifths gives us iii. The mediant is one of the most “remote” harmonies, and it is fairly rare in both classical and pop music. But if we felt like it we could certainly start at I, go all the way out to iii, and then work our way back to tonic.

C: iii vi ii V I

C: I iii vi IV V I

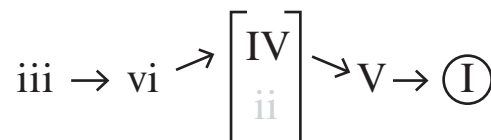

Switching between subdominants

One more thing we can do now that we know how to move by thirds is to spend extra time in the subdominant zone, switching between ii and IV or vice-versa.

C: I IV ii V I

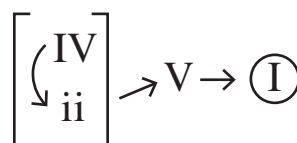

More progressions are possible

Our progressions flowchart expresses how a fairly conventional classical composer like Mozart would order his or her chords. Many more things are possible! You can look at the progressions you see in other kinds of music and compare them to these. Often it still seems like they are still moving around within our flowchart, only in unexpected ways.

Summary: Progressions with the Four Moves

If you can learn these four things you will be able to make any basic progression* at the keyboard.

The Situation

Bass moves by **fourth or fifth**.

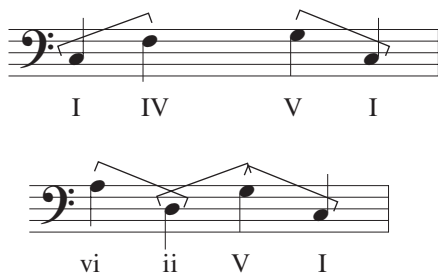

Your Move

Common-tone connection



Next-closest connection



Bass moves by **step**
(usually up)

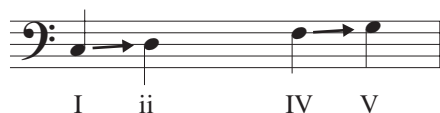

Step zone - slide in the opposite direction
to your nearest chord
(usually down)

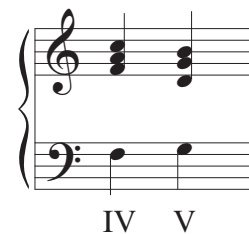

Bass moves **by third or sixth**
(usually down a third / up a sixth)



Double common-tone - two notes stay
put, one note slides into place



* Our progressions are all close position (stacked tight) with the root in the bass, all triads no seventh chords. Adding more possibilities introduces more "moves."

Chapter 21: Enter the Matrix

As we know from the movies, the Matrix is a computerized simulation of real life that is engineered to keep humans enslaved by their robotic overlords. In music theory it also means something very specific pertaining to 12-tone music that we don't need to worry about yet.

I think "the Matrix" is also a good metaphor for the way intervals interact in a chord progression, but this is just my own personal joke. No one else uses this term in this way, just so you know. :)

In this chapter I'm going to show you how I evaluate any progression to determine whether there are parallels in it. If you can learn this trick you will be like Neo, able to see through the fabric of reality and understand its essence.

Horizontal and Vertical Intervals

You may be aware that notes that are combined together simultaneously into chords are sometimes called *vertical* intervals, and the intervals in a melodic line are *horizontal*.

When we are thinking about parallels, our horizontal and vertical intervals have a crucial interrelationship. If we move *the same distance* in each voice we'll make *the same vertical interval* each time.



These two parts move horizontally up a step. Therefore, both of the vertical intervals are the same. In this case we make parallel sixths.

Good Parallels and Bad Parallels

Another thing that is important to understand is that not all parallel verticals are bad. Parallel thirds and sixths are fine! Parallel fifths and octaves, on the other hand, are banned in traditional counterpoint.

GOOD	GOOD	BAD	BAD
parallel sixths	parallel thirds	parallel fifths	parallel octaves

So, once we detect some parallel motion, we'll have to ask "is this a good parallel or a bad parallel?"

Taking an Inventory of Horizontal Intervals

The first thing we will do is look at every horizontal connection between two chords in our progression, and we'll make a little mental list of what every part is doing.

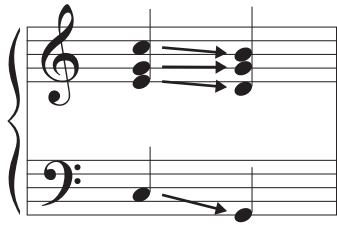

S: goes down a step
 A: doesn't move
 T: goes down a step
 B: goes down a fourth

Here the "soprano" and "tenor" parts are both doing the same thing! So we need to check them out more closely, to decide if they make good or bad parallels.

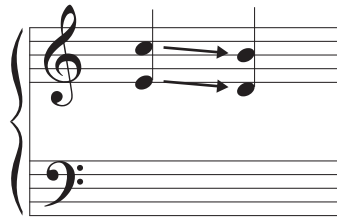

Soprano & Tenor make parallel sixths, which are good.

This is the only pair of voices that hooks up in parallel motion. All of the other parts are doing other things, so this progression checks out.

Let's look at one more. This is something you might write if you were trying to shift from "close" position to "open" position.

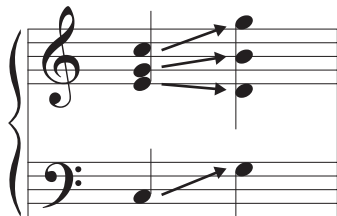

S: goes up a fifth
 A: up a third
 T: goes down a step
 B: up a fifth

Here the top and bottom voices are doing the same thing, and it isn't good!

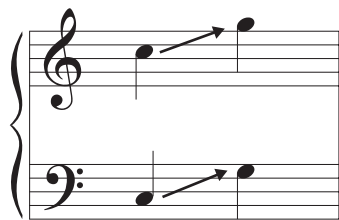

Soprano & Bass make parallel octaves, which are bad.

So far this method is pretty simple, but unfortunately there is one more thing to worry about.

Successive Fifths or Octaves by Contrary Motion

Perhaps you remember that you also aren't allowed to flare out in opposite directions and make two fifths in a row, or two octaves.

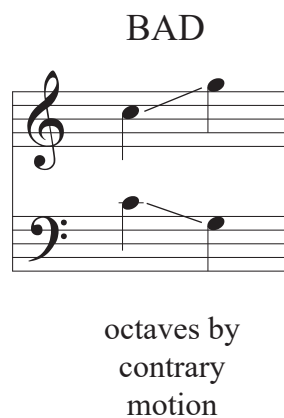
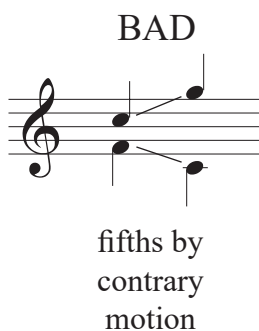

To detect fifths and octaves by contrary motion we are going to scan our inventory for pairs of **opposite intervals** going in **the opposite direction**.

In our discussion of interval inversions we learned that certain intervals turn into other, "opposite" intervals when they are flipped around.

2nds ↔ 7ths
3rds ↔ 6ths
4ths ↔ 5ths

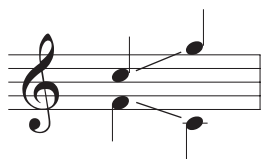

Our examples of 5ths and 8ves by contrary motion pair a horizontal fifth up with a fourth down.

Of course once we detect this kind of motion we need to consider whether we are making good or bad successive intervals. There is such a thing as successive 3rds or 6ths by contrary motion, which are fine.

Let's look at one more example.

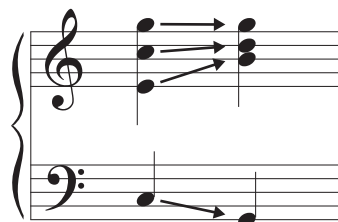

S: doesn't move
 A: up a step
 T: up a fifth
 B: down a fourth

So first off, all of the parts are doing different things, so there are zero parallels. BUT we can see one pair that is doing a fifth + a fourth combo in opposite directions.



Tenor and Bass shoot out in opposite directions to make successive **thirds**, which are actually fine.

So, after careful scrutiny this one checks out!

Do You Really Need To Be In The Matrix

Maybe not? In longer theory sequences we write with a wider variety of techniques, and students churn out a lot of weird-looking progressions. This is the method I use to evaluate what they write, and I think it's the only way to be really confident that something is considered correct.

However, in this class we are just learning a few simple techniques that you can do quickly. If you stick to those (namely common tone, next-closest, step-zone and double common-tone) you can make progressions and not worry about them too much.

However, if you ever create something a little different and want to check it out carefully, this method is for you.

Chapter 22: Seventh Chords

Seventh chords simply add another note to our stack of thirds. The new note is a seventh above the root and it introduces a little dissonance to the overall sound.

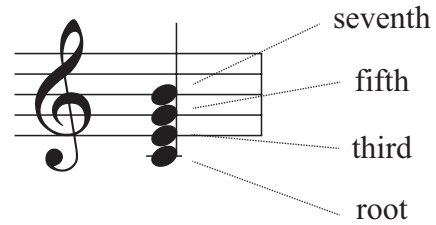

We are going to learn how to make and recognize five different kinds of seventh chords. Let me list them here, starting with the most spread-out one (the major seventh) and proceeding to the most compact one (the fully diminished seventh).

A musical staff showing five types of seventh chords. The notes are stacked vertically for each chord. The labels below the staff are: major 7th, dominant 7th, minor 7th, half-diminished 7th, and fully diminished 7th.

major 7th	dominant 7th	minor 7th	half-diminished 7th	fully diminished 7th
major 7th	dominant 7th	minor 7th	half-diminished 7th	fully diminished 7th

Major seventh

The major seventh has a **major triad** on the bottom, and the distance from root to seventh is a **major seventh**.

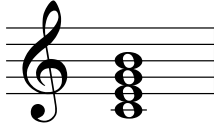

C major 7th chord

Remember that the seventh can be inverted around to its “opposite.” A major 7th inverts around to a minor 2nd, or a half-step below the root.

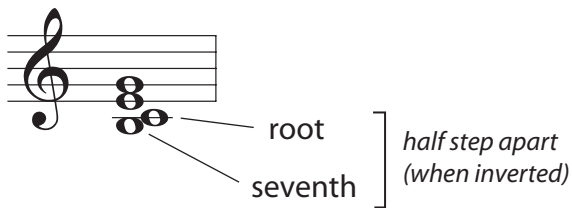

This is an easy and reliable way to calculate what your seventh should be.

In roman numeral analysis we mark our major-seventh chords with a capitalized roman + “M7”

I^{M7}

Some people like other roman-numeral notations, including a triangle to mean major.

I^{Maj7} I^{Δ7}

Dominant seventh

The dominant seventh has a **major triad** on the bottom, and the distance from root to seventh is a **minor seventh**.

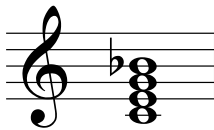

C dominant 7th chord

Inverting the chord makes a whole step between root and seventh.

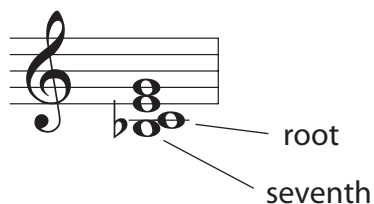

Dominant seventh chords are so common that they get the roman numeral with a “plain” 7. V^7 is by far the most frequent usage, so we’ll analyze our sample chord as V^7 in F major.

F: V^7

Some textbooks are apparently anxious to reserve the term “dominant 7th chord” for chords that are actually built on the $\hat{5}$ of the key. They use “major-minor 7th” to describe this shape in more general terms. I think most musicians would agree that this is unnecessarily fussy.

Minor seventh

The minor seventh has a **minor triad** on the bottom, and the distance from root to seventh is a **minor seventh**.

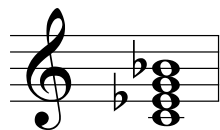

C minor 7th chord

Again, flipping it around makes a whole step between root and seventh.

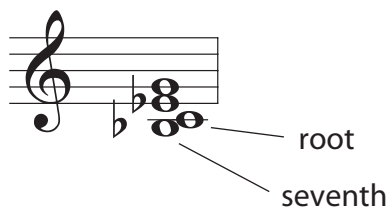

For roman numerals you would use a lowercase letter and a 7. Let’s imagine this is a i^7 in C minor.

c: i^7

Half-diminished seventh

If we compress our triad down to a **diminished triad** on the bottom, but keep our **minor seventh**, we get a “half-diminished” seventh.

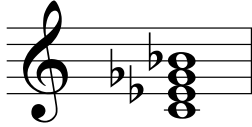

C half-diminished 7th

So of course the name implies that this is an unfinished job, since it is possible to “fully” diminish a seventh chord but somehow we have failed. A real fully-diminished seventh is a stack of all minor thirds, but here we have neglected to compress the top third.

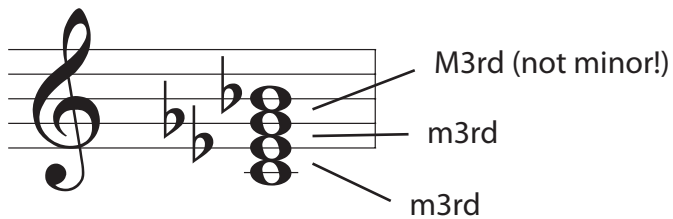

For roman numerals you use a diminished circle with a line through it. You may see the half-diminished seventh as the $\text{vii}^{\circ 7}$ in a major key, so let’s analyze this chord as though it is in D^{\flat} major.

$\text{D}^{\flat} : \text{vii}^{\circ 7}$

Fully-diminished seventh

A fully-diminished seventh chord has a **diminished triad** on the bottom and a **diminished seventh** from root to seventh.

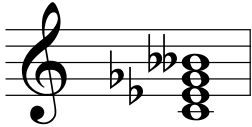

C fully-diminished 7th

It is a stack of all minor thirds.

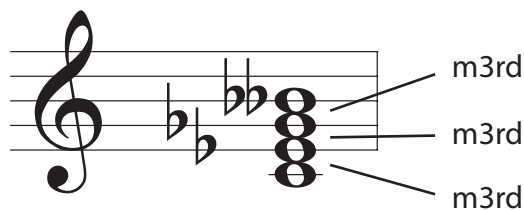

The outside interval (the diminished seventh) is a tricky one that is the same size as the major sixth, 9 semitones. When you invert it you get an augmented second (3 semitones).

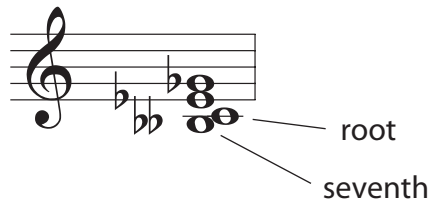

This chord is another exception to our rule about not mixing sharps and flats. The fully-diminished seventh will frequently have a sharp on the bottom and a flat on the top. For instance, here is a C# fully-diminished seventh.

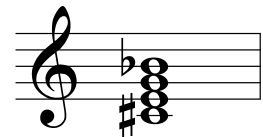

With the roman numerals it gets the diminished circle with no slash. You will often see it as $\text{vii}^{\circ 7}$ in a minor key. For an example, we can analyze our C# diminished 7th as $\text{vii}^{\circ 7}$ in D minor.

d: $\text{vii}^{\circ 7}$

Diatonic Seventh Chords

The way seventh chords fit into a key is fairly straightforward. Here are the diatonic seventh chords for a major key:

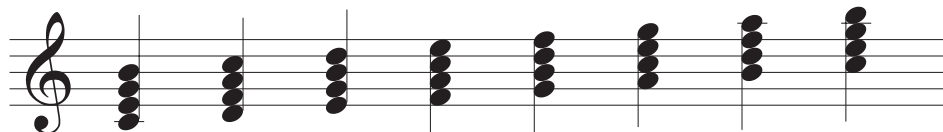

A musical staff in treble clef showing the diatonic seventh chords for C major. The notes are: C4, E4, G4, Bb4 (I^{M7}); D4, F4, Ab4, C5 (ii⁷); E4, G4, Bb4, D5 (iii⁷); F4, Ab4, C5, Eb5 (IV^{M7}); G4, Bb4, D5, F5 (V⁷); A4, C5, Eb5, G5 (vi⁷); Bb4, D5, F5, Ab5 (vii^{ø7}); C5, E5, G5, Bb5 (I^{M7}).

C: I^{M7} ii⁷ iii⁷ IV^{M7} V⁷ vi⁷ vii^{ø7} I^{M7}

In minor keys, we still raise our leading tone for V⁷ and vii^{ø7}. Building vii^{ø7} on the raised leading tone is what makes it fully diminished.

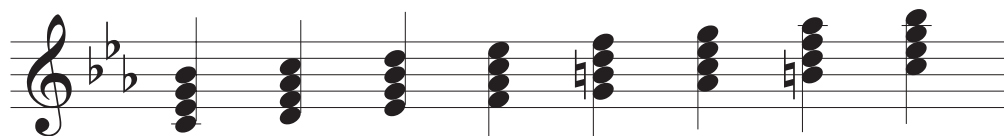

A musical staff in treble clef with two flats (Bb, Eb) showing the diatonic seventh chords for C minor. The notes are: C4, Eb4, Gb4, Bb4 (i⁷); D4, Fb4, Ab4, C5 (ii^{ø7}); E4, Gb4, Bb4, D5 (III^{M7}); F4, Ab4, C5, Eb5 (iv⁷); G4, Bb4, D5, F5 (V⁷); A4, C5, Eb5, G5 (VI^{M7}); Bb4, D5, F5, Ab5 (vii^{ø7}); C5, Eb5, G5, Bb5 (i⁷).

c: i⁷ ii^{ø7} III^{M7} iv⁷ V⁷ VI^{M7} vii^{ø7} i⁷

Chapter 23: Inversion Symbols for Roman Numeral Analysis

When we are trying to understand the harmonies in a piece of music, we will sometimes find inverted chords (with a third, fifth, or even a seventh as the lowest note.) When this happens, we add extra symbols to our roman numerals.

The Symbols for Inverted Triads

The inversion symbols for triads are easy enough to just memorize. If a triad is in root position, we add nothing. If it is in first inversion we add a little ⁶, and if it is in second we add a ₄.

I in root position =	I
I in first inversion =	I ⁶
I in second inversion =	I ₄ ⁶

These are abbreviations

The little numbers are really abbreviations of some terminology I introduced in Chapter 16. Perhaps you remember that I described the root position triad as a “5-3 shape.” First and second inversions were said to be a “6-3 shape” and “6-4 shape.”

Now imagine that we want to save as much effort as possible and so we omit some of this information. We assume that the 5-3 shape is the default and we decide that this is not worth indicating. 6-3 differs from 5-3 in the top note, so we include that info whenever we see a triad in first inversion. A 6-4 chord differs from the 5-3 in both parts, so it gets both numbers.

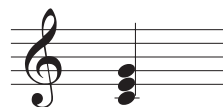

$\begin{matrix} \times \\ \times \end{matrix}$ shape

I

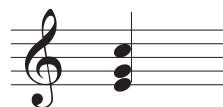

$\begin{matrix} 6 \\ \times \end{matrix}$ shape

I⁶



$\begin{matrix} 6 \\ 4 \end{matrix}$ shape

I₄⁶

Figured Bass

These weird numbers come from a musical tradition called figured bass - it's the way composers used to write out chord progressions starting around the year 1600, the beginning of the Baroque era. They would write a bass line and these extra numbers, like so:

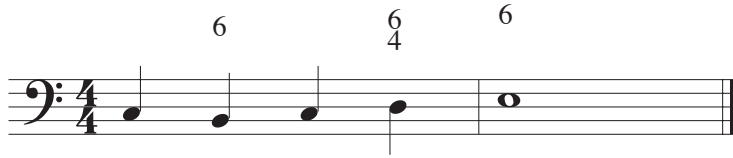

The combination of bass line and extra numbers would tell a harpsichordist or lutenist what chords to play. For each note with no number, the accompanist would assume that it represents a root-position triad. They would figure out whether it was major, minor, or diminished by thinking about whatever would fit in the key they are in. So if we are in C major, the first chord in this progression would be a C major triad.

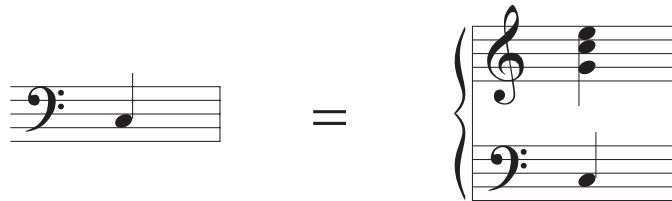

When we have a note with a 6 over it, the composer is saying “this bass note is the third of the chord.” So the accompanist would think backwards and figure out that this is a G major triad with a B in the bass. We have to make a somewhat odd-looking shape on top because you aren't allowed to double B, the leading tone.



For our fourth bass note we have a $^6/4$, which means “this note is the fifth of the chord.” We realize that G major is the triad with D as the fifth, so we make that up above.

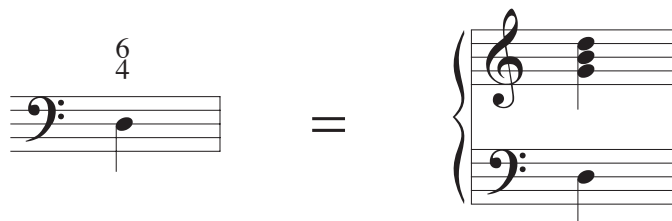

The exact makeup and position of the upper chords are not really specified - the harpsichorist or lutenist was free to put together the chords in any way they saw fit. In that sense it was similar to being the rhythm guitarist or pianist in a rock or jazz combo.

We could play our figured bass as the following two-handed progression, but many other variations would be possible!

The image shows a musical example of figured bass. On the left, a single bass line in 4/4 time contains four measures: G, A, B, C. Above the notes are figured numbers: 6, 6/4, 6. An equals sign follows. To the right, a two-handed piano progression is shown in 4/4 time. The right hand plays chords corresponding to the notes in the bass line, and the left hand plays the notes G, A, B, C. The first three measures show triads, and the fourth measure shows a dyad (G and C).

So, that's where these numbers come from. If you continue your theory studies to a more advanced level you may be asked to create progressions from a figured bass part.

This is a Classical music thing

Much of what we've studied in this text is applicable to many different kinds of music, but people mostly use the roman numerals with these figured bass numbers to analyze "Classical"-type works (including Baroque, Romantic, and some Modern as well, anything that is all written out note-for-note in a score.)

Guitar books, jazz lead sheets and the like will usually use a slash notation to indicate when a note other than the root goes in the bass.

$$A / C\# = \text{A major in first inversion.}$$

Figured Bass Numbers for Seventh Chord Inversions

Seventh chords can be inverted just like triads, and just like with triads we have to memorize some figured-bass numbers for our roman numeral analyses. These are a little harder to learn! In the diagram below I'll make a bunch of V^7 's in C major, and I'll use their figured-bass numbers to indicate inversions.

	root position	1st inversion	2nd inversion	3rd inversion
C:	V^7	V^6_5	V^4_3	V^4_2

These are abbreviations

Like before, these are abbreviations of the full information. The root position is the default, so it just gets a ⁷. First and second inversion include enough symbols to tell you where the step between seventh and root is. Third inversion is a bit awkward, since the step is against the bass, so it *sort of* tells you where this interval is. Some texts just use ², which is maybe more consistent.

root		=	$\begin{matrix} 7 \\ \cancel{5} \\ \cancel{4} \end{matrix}$	=	V^7
1st		=	$\begin{matrix} 6 \\ 5 \\ \cancel{4} \end{matrix}$	=	V^6_5
2nd		=	$\begin{matrix} \cancel{6} \\ 4 \\ 3 \end{matrix}$	=	V^4_3
3rd		=	$\begin{matrix} \cancel{6} \\ 4 \\ 2 \end{matrix}$	=	V^4_2

Chapter 24: Intro to Harmonic Analysis

Since we've done so much work learning our scales, triads, and roman numerals, it's time to start looking at pieces of music to see what's going on. Roman-numeral analysis and other analytic techniques are a major part of the discipline of music theory.

Looking for chords

One of our first tasks in analyzing a piece is to look for chords. Sometimes this is easy, as the notes make nice vertical stacks that are obviously chords. In other situations this can be very tricky, as every single part is highly embellished and we have to "see through" a lot of details to find the harmony underneath. We'll start with a fairly easy example. :)

Haydn's String Quartet in D Major Op. 76 No. 5, second movement, mm. 1-4

Largo. Cantabile e mesto

Here are the first four measures of a Haydn string quartet slow movement. I've simplified the score for you so that it looks like piano music. The first violin plays a graceful melody while the other three parts play long notes that make chords. Let's dig in and figure out the first three harmonies.

F#: I

We are in the key of F# major, and Haydn starts with a nice neat stack of thirds, F#-A#-C#. This is pretty obviously the tonic chord, so we can stick a roman numeral I underneath the music.

We scan the melody for anything interesting, but it seems very straightforward - it is just arpeggiating around that same I chord. Sometimes the melody gives us additional information that would cause us to revise our harmonic interpretation, but not here.

We scan forward in the music, looking for the clues that the harmony has changed. The I chord seems to last for the first five beats, and then the Violin II and Viola shift their notes. This is a new chord.

F#: I new harmony!

This harmony is perhaps mildly confusing, so let's look at it extra carefully. We'll take an inventory of our notes, looking at them one-by-one and writing the letter-names up above the music.

F# B D# D# B F#

F# B D# D# B = B major triad
F# B D# F#

We may have to “unscramble” these note names to arrive at a chord we know. Here it isn't too hard to recognize that this triad is really B-D#-F#, or a B major triad.

That's IV in the key of F#. In addition, the violin melody is clearly just arpeggiating the notes of IV as well, so we can confidently put our roman numeral underneath the music.

F#: I IV_{6/4}

Now, this B major triad is a little interesting because it does not have B in the bass. Instead, the F# holds over from the previous chord. Thus, our IV is in second inversion. In Classical music analysis we indicate that a chord is inverted by sticking figured-bass numbers after the roman numeral - here we'll add a 4.

$$IV_4^6 = IV \text{ in second inversion}$$

On the third beat the Violin II and Viola sink back down, and again it's pretty easy to see that this is the I chord. The F# in the cello holds over into beats 3 and 4, so this is actually in root position. The melody also arpeggiates I.

F#: I IV₄⁶ I

We've figured out the first harmonic shift in this string quartet, from I to IV₄⁶ back to I. After this it gets more complicated, but with a little more experience we could surely figure out the entire movement.

So, to summarize some of the points in this discussion:

Look for chords first, then consider the melody.

Spell out anything that looks complicated above the staff, and try to "unscramble" it.

We will add the extra little numbers after our roman numerals to indicate inversions.

Chapter 25: Non-Chord Tones

Most of the music you hear every day is based on chord progressions. A composer chooses a sequence of chords, and the notes in the progression provide a sort of backbone or framework for the music. It is possible to make an entire melody out of selected notes from the chords, like with this familiar folk tune:

The image shows two staves of musical notation in 4/4 time, F major. The first staff contains the first six measures of the melody. Above the notes, chord progressions are indicated: F major (3rd, root, 5th) for the first three measures, and C (3rd, root, 5th) for the last three measures. The lyrics are "Good night la-dies, ___" and "good night la - dies! ___". Roman numerals I and V are placed below the first and last measures respectively. The second staff contains the next six measures. Above the notes, chord progressions are indicated: F (3rd, root) and Bb (root) for the first two measures, F (3rd) and C (5th) for the next two measures, and F (root) for the final measure. The lyrics are "Good night la - dies, ___" and "we're going to leave you now."

However, we usually need more notes to flesh out the music. We add decorations and even interesting distortions to our harmonies in order to make it all sound a little more alive. These extra, added notes are called *non-chord tones*.

In order to illustrate the various kinds of NCTs I'm going to use a few graphic symbols:

- = chord tone (consonant, stable)
- = non-chord tone (dissonant, subservient to more stable note)
- ↗ = stepwise connection

Basic melodic NCTs

First, let's consider some fairly simple ways to elaborate a musical line.

Passing tone

A passing tone comes from a note and continues on to a different note.

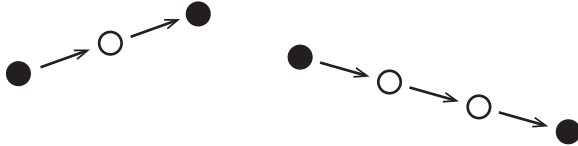

C: I

Neighbor tone

A neighbor tone goes back to the same note it came from.

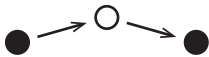

C: I

Double neighbor

Instead of going immediately back to the note it came from, a double neighbor figure makes an “above, below, then back” pattern (or the opposite.)

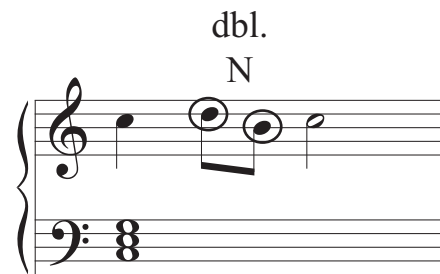
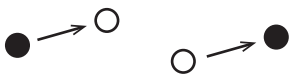

C: I

Appoggiatura [from the Italian word “to lean”]

Also known as an “incomplete neighbor.” An appoggiatura resolves to a chord tone, but it is approached by leap or just out of the blue.

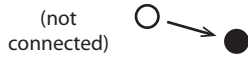

C: I

C: I

Escape Tone

The escape tone is the only NCT that doesn't resolve to another chord tone - instead it comes *from* a chord tone. It's the opposite of the appoggiatura. The most common use of ET's in classical music is to decorate a scalar ascent or descent, like the example on the right.



C: I ii⁶ I₄⁶ V I

A few interesting distinctions

Diatonic vs. Chromatic

Diatonic NCTs use tones that belong to the scale. Chromatic NCTs use tones that are outside the scale (and require accidentals.)

A passage with mostly chromatic non-chord tones

C: I

Accented vs. Unaccented

An unaccented non-chord tone will be relatively “weak” and “unimportant” compared to the notes around it. An accented NCT, however, will stick out - it falls on the beat or it is longer than surrounding notes. You can mark accented P’s, N’s, or app’s with a little accent mark.

C: I

Displacement NCTs - ant., sus., ret., pedal

We also have a few NCTs that involve notes being where they don't belong - they either arrive early or hang on late.

Anticipation

Here a note simply comes in early instead of waiting for the next chord. All of these displacement NCTs can involve either a sustained note (which is held through more than one harmony) or a repeated note. Anticipations are frequently a repeated note.

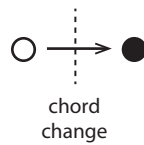

ant.

Suspension

Suspensions are perhaps the coolest NCT, but they also involve the most complicated theoretical baggage. Simply put, a suspension hangs over from the previous harmony and then *resolves down by step* into the new harmony.

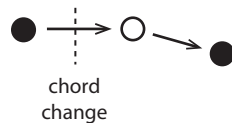

For some reason theorists like to classify suspensions with figured bass numbers. Remember that figured bass numbers are all about the interval above the bass - when you figure out your suspension labels you don't have to think about what the roman numeral is, or the key - just measure the interval above the actual bass note. Look carefully at these examples and see if you can understand where the numbers come from.

4-3 sus

C: IV I

7-6 sus

C: V₄⁶ I⁶

This one is always called “9-8” (even though we might be tempted to say “2-1.”)

9-8 sus

C: V I

A suspension in the bass is always called “2-3.” It refers to the fact that somewhere in the chord there is a tone that the bass is dissonantly rubbing up against - it makes a second against the bass, but once it resolves it makes a consonant 3.

2-3 sus

C: I V⁶

Retardation

If a held-over note doesn't resolve down, it isn't a suspension. It's a retardation. Retardations are less common than suspensions, and they usually don't get the fancy figured-bass style labels.

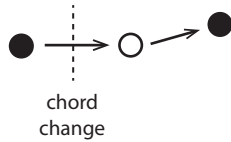

ret.

C: V I

Pedal Tone

A pedal tone is held across a number of harmonies. It is usually in the bass, and usually on scale-degrees $\hat{1}$ or $\hat{5}$. The harmonies on top usually go away from and then back to consonance with the pedal tone. You can analyze it in two layers - on the bottom you can indicate "Pedal V" (or "Pedal I"), and then in an upper layer you can track the harmonies that happen over the bass (with no inversion symbols.)

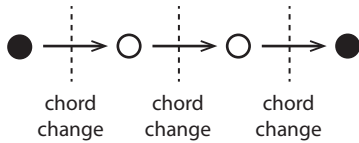

C: pedal V ————— I

Chapter 26: Progressions with V7

The most common seventh chord in the world is probably V^7 , which usually wants to resolve to I. In this chapter I will show you two quick formulas to write progressions with this slightly spicy harmony.

Tendency Tones

There is often a sense that the tones of a V^7 chord “want” to resolve in a certain way. This is probably caused by a combination of cultural and perceptual factors.

Let us consider a V^7 chord in C major:

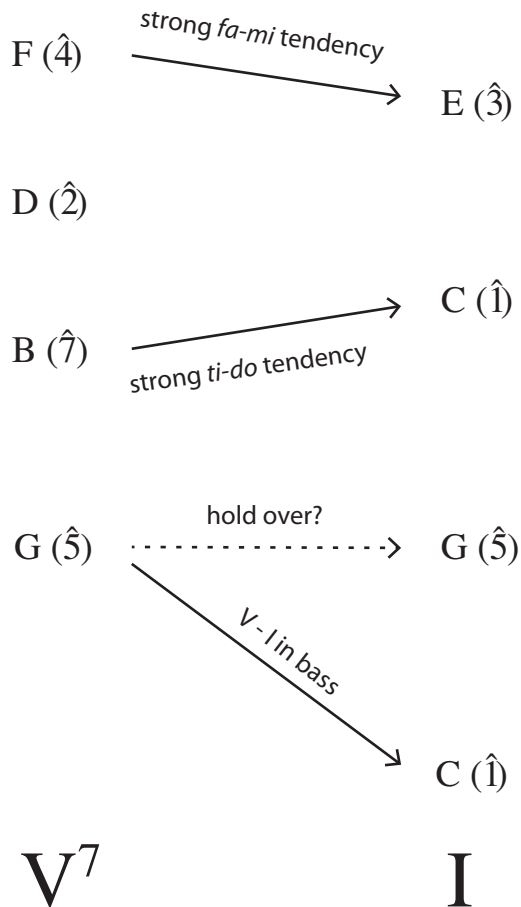

As it resolves, the leading-tone (*ti*, the third of the chord) “wants” to go up to *do*. The seventh of the chord (*fa*) also wants to resolve down to *mi*, especially in major keys. (There is something about the closeness of the target note, only a half-step away, that seems to make these resolutions particularly satisfying.)

What the remaining tones want to do is more of a practical matter than a perceptually urgent one. The fifth of the chord (*re*) maybe has a weak tendency to go to *do*, but it could easily go up to *mi* if it needs to.

What you want to do with the root of the V^7 (*sol*) depends on where it is in the texture. If it is your bass note, you probably want to jump to *do* to make the V-I bass line. However, if it is in an upper voice it can be a common tone that holds over into I.

The Frustrated Leading-Tone

Theorists are particularly concerned with the tendency of the leading tone, which wants to go from *ti* to *do*. If the leading tone is in the top line of your V or V⁷ chord, it must go to *do* or else it is called a “frustrated leading tone.”

This is true even with a plain V chord! The idea is that leaping away from the leading tone is disappointing, because we anticipate the conventional resolution to *do* and will be annoyed if we don't get it.

A musical score in treble and bass clefs. The bass line shows a sequence of notes: C2, G2, F2. The treble line shows three chords: ii (C4, E4, G4), V (C4, E4, G4, B4), and I (C4, E4, G4). An arrow points to the B4 note in the V chord, labeled "frustrated l.t.".

A plain V chord with frustrated leading tone.

However, this rule is actually pretty narrow - it only applies when the leading tone is exposed in the top voice and you leap away from it instead.

If you hide the leading tone in an inner voice it's considered fine. This will actually be one of our strategies to make good V⁷-I's.

A musical score in treble and bass clefs. The bass line shows notes: C2, G2, F2. The treble line shows two chords: V⁷ (C4, E4, G4, B4) and I (C4, E4, G4). An arrow points to the B4 note in the V⁷ chord, which is in the inner voice.

Frustrated leading tone in inner voice (which is fine)

There are also a few situations where the leading tone might connect downward by step that are not at all disappointing.

A musical score in treble and bass clefs. The bass line shows notes: C2, G2, F2, E2, D2. The treble line shows five chords: I (C4, E4, G4), iii (C4, E3, G3), IV (C4, E4, G4), V (C4, E4, G4, B4), and I (C4, E4, G4). An arrow points to the B4 note in the V chord, which connects downward by step to the A4 note in the final I chord.

In this progression, the leading tone is part of the iii chord. It continues down by step and I don't think anybody would object. Stepwise connections are strong, so the motion from C-B-A is compelling and not disappointing in any way.

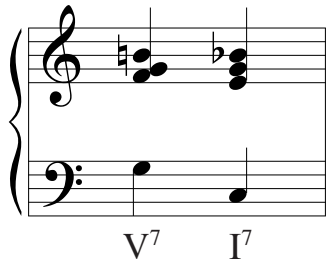

Similarly, in contexts where we go from one dominant seventh to another, the third of one chord often sinks down to the seventh of the next. Let us imagine that we are going from a V^7 to a I^7 (in some kind of bluesy context, perhaps). This is also fine.

So with all of this tendency-tone business out of the way, let's look at two quick strategies to make good V^7 - I progressions.

Strategy #1 - Omit the fifth, double the root

Surprisingly, you don't need to use all of the notes in your dominant seventh chord. You can omit the fifth, and nobody will miss it.

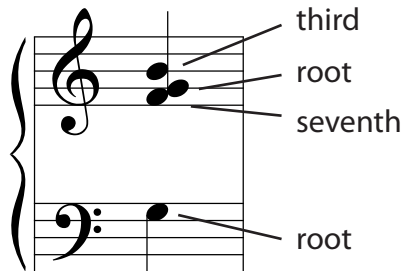

With this technique you build V^7 with the root on the bottom and root, third, and seventh on top.



After that you follow all of your tendency tones. *Ti* goes to *do*, *fa* goes to *mi*, and that extra *sol* in the upper voices holds over as your common tone. This will make a normal-looking I chord.

There are a few ways to rotate around your upper tones. I like the formation I've been using above because it fits very comfortably under the hand, but there are two other possible options as well.



Strategy #2 - Frustrated leading tone in an inner voice

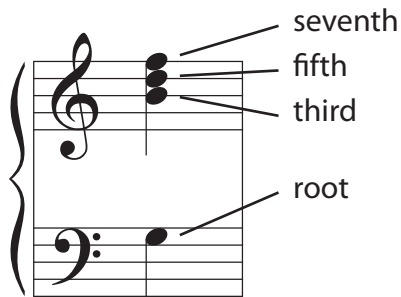

Here we will use all four tones of the V^7 . The root is in the bass, everything else is on top, and you should make sure the leading tone (i.e. the third of the V^7) is somewhere in an inner voice.

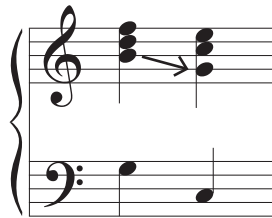

The leading tone ducks down to *sol*. Everything else slides into place.

Because *ti* is in an inner voice, it is not considered “frustrated.” (You might say it is frustrated but nobody notices, so life goes on. It may have to do a little therapy later to deal with any residual disappointment.)

Because the third of the chord cannot be on top, there are only two rotations of this voice-leading strategy we can use.

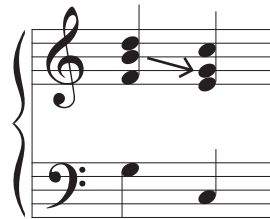
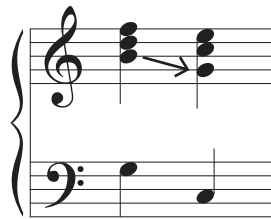

Getting in to your V7

It's pretty hard to get into trouble as you enter into your V7 as long as you make smooth connections and remember your step zone. Let's consider three likely progressions that will contain V7.

I - V⁷ - I and ii - V⁷ - I

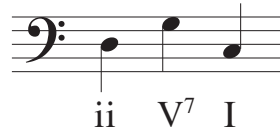

With either of these, the bass is jumping into the V7 by fourth or fifth. Remember not to jump too much in your upper voices.

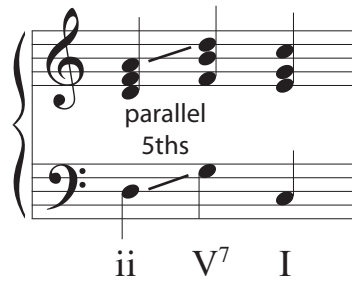

If you jump by 4th or 5th in your upper parts you will probably hook up with the bass in parallel fifths or octaves, or you may make fifths or octaves by contrary motion.



We can do it correctly by slightly adapting our common-tone and next-closest techniques. This progression makes a very smooth connection into the V⁷ by keeping two common tones.

I - IV - V⁷ - I

Here there is a step zone from IV to V, so you want to make most of the upper voices go in the opposite direction.

A piano accompaniment for the progression I - IV - V⁷ - I. The bass line is the same as in the first diagram. The treble clef shows chords for I, IV, V⁷, and I. Dotted lines connect the notes of the IV and V⁷ chords, showing parallel 5ths. The text "parallel 5ths" is written between the two chords.

If you don't, you might make bad parallels against the bass.

A piano accompaniment for the progression I - IV - V⁷ - I. The bass line is the same. The treble clef shows chords for I, IV, V⁷, and I. Dotted lines connect the notes of the IV and V⁷ chords, showing nice contrary motion. The text "nice contrary motion" is written between the two chords.

...so we want to pull most (or all) of the parts downward, in contrary motion. Here we hold over the F and move down the other two.

Overall, if you have a good feel for our older techniques and you learn our two new strategies for building and resolving V⁷ it should be easy to write these more interesting progressions and avoid problems.

Of course it might also help to read our Chapter 21 ("Enter the Matrix") to learn how to rigorously scan for errors. Learning my "matrix" procedure will also improve your intuitive understanding of good counterpoint.

Let's conclude with annotated examples of various possible progressions that include V^7 . This is not an exhaustive listing by any means.

modified common tone strategy #1

I V^7 I

modified next-closest? strategy #2

I V^7 I

common tone step zone strategy #1

I IV V^7 I

common tone step zone strategy #2

I IV V^7 I

step zone modified next-closest strategy #1

I ii V^7 I

step zone modified common tone strategy #2

I ii V^7 I